

**UTM10 Series**  
**Ultrasonic Transit-time Flowmeters**  
**Installation and Maintenance Instructions**

---

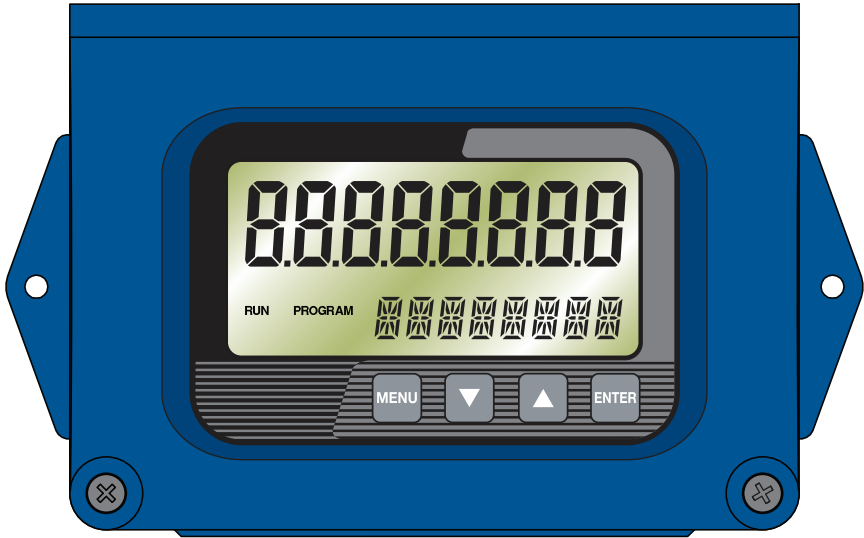



# Contents

<b>Safety information</b>	<b>7</b>
Intended use	8
Access	8
Lighting	8
Hazardous liquids or gases in the pipeline	8
Hazardous environment around the product	8
The system	8
Pressure systems	9
Temperature	9
Tools and consumables	9
Protective clothing	9
Permits to work	9
Handling	9
Residual hazards	9
Freezing	9
Disposal	9
<b>Introduction</b>	<b>10</b>
General	10
Application versatility	10
CE compliance	11
User safety	11
Data integrity	11
Product identification	11
<b>Transmitter installation</b>	<b>12</b>
General information	12
Transducer connections	13
Line voltage ac power connections	14
Low voltage ac power connections	15
dc power connections	16

**Transducer installation . . . . . 17**

- General . . . . . 17
- Step 1 - Mounting location . . . . . 17
- Step 2 - Transducer spacing . . . . . 19
- Step 3 - Entering pipe and liquid data . . . . . 21
- Step 4 - Transducer mounting . . . . . 22
- V-mount and W-mount installation . . . . . 23
- UTT10 small pipe transducer installation . . . . . 25
- Mounting transducers in Z-mount configuration . . . . . 28
- Mounting rail and track installation . . . . . 31

**Inputs and Outputs . . . . . 32**

- General . . . . . 32
- 4-20 mA output . . . . . 32
- Control outputs UTM10-S only . . . . . 33
- Frequency output UTM10-S only . . . . . 35
- Totalizer output (energy model) . . . . . 37
- RS485 . . . . . 38
- Ethernet port . . . . . 39
- USB programming port . . . . . 39
- Energy flow UTM10-E only . . . . . 39

**Quick-start operating instructions . . . . . 43**

- Transducer location . . . . . 43
- Electrical connections. . . . . 44
- Pipe preparation and transducer mounting . . . . . 44
- Start-up . . . . . 45

**Start-up and Configuration. . . . . 46**

- Before starting the instrument. . . . . 46
- Instrument start-up procedure . . . . . 46
- Keypad programming . . . . . 47
- Menu structure . . . . . 48



BSC menu - Basic menu . . . . .	48
CH1 menu - Channel 1 menu . . . . .	58
CH2 menu - Channel 2 menu . . . . .	60
SEN menu - Sensor menu . . . . .	62
SEC menu - Security menu . . . . .	63
SER menu - Service menu . . . . .	63
DSP menu - Display menu . . . . .	68
<b>Software utility . . . . .</b>	<b>70</b>
Introduction . . . . .	70
System requirements . . . . .	70
Installation . . . . .	70
Initialization . . . . .	70
Basic tab . . . . .	71
Flow tab . . . . .	74
Filtering tab . . . . .	76
Output tab . . . . .	78
Channel 1 - 4-20 mA configuration . . . . .	79
Channel 2 - RTD configuration UTM10-E only . . . . .	80
Channel 2 - Control output configuration UTM10-S only . . . . .	82
Setting zero and calibration . . . . .	84
Target Dbg data screen - Definitions . . . . .	87
Saving the flow meter configuration onto a PC . . . . .	87
Printing a flow meter configuration report . . . . .	87
<b>Appendix . . . . .</b>	<b>88</b>
Specifications . . . . .	88
Menu Maps . . . . .	92
Communications protocols . . . . .	94
Heating and cooling measurement . . . . .	100
UTM10 error codes . . . . .	105
Product labels . . . . .	106

Control drawings . . . . .	107
CE compliance drawings . . . . .	115
K-factors explained . . . . .	116
Table 23 - Fluid properties . . . . .	118
Symbol explanations . . . . .	120
Table 24 - ASME pipe data . . . . .	121
Table 25 - ASME pipe data . . . . .	122
Table 26 - Copper tube data . . . . .	123
Table 27 - Ductile iron pipe data . . . . .	124
Table 28 - Cast iron pipe data . . . . .	125

**Please note:**

BELDEN is a registered trademark of Belden Technologies, Inc.

BACNET is a registered trademark of American Society of Heating,

CSA is a registered trademark of the Canadian Standards Association.

Refrigerating and Air-Conditioning Engineers (ASHRAE).

WINDOWS, VISTA and EXCEL are registered trademarks of Microsoft Corporation.

NATIONAL ELECTRICAL CODE is a registered trademark of the NFPA.

SONOTEMP is a registered trademark of Sonotemp, Inc.

ULTEM is a registered trademark of General Electric Company.







VESPEL is a registered trademark of E.I. DuPont Nemours and Company.

## *1. Safety information*

**Safe operation of these units can only be guaranteed if they are properly installed, commissioned and maintained by a qualified person in compliance with the operating instructions. General installation and safety instructions for pipeline and plant construction, as well as the proper use of tools and safety equipment must also be complied with.**

**These products are designed and constructed to withstand the forces encountered during normal use. Use of these products for any other purpose, or failure to install these products in accordance with these Installation and Maintenance Instructions, could cause damage to the products, will invalidate their markings, and may cause injury or fatality to personnel.**

The symbols, used on the product and in this manual, mean:

	<b>Equipment protected throughout by double insulation or reinforced insulation.</b>
	<b>Functional earth (ground) terminal, to enable the product to function correctly. Not used to provide electrical safety.</b>
	<b>Caution, risk of electric shock.</b>
	<b>Caution, risk of danger, refer to accompanying documentation.</b>
	<b>Optically isolated current source or sink.</b>
	<b>Caution, Electrostatic Discharge (ESD) sensitive circuit. Do not touch or handle without proper electrostatic discharge precautions.</b>

## 1.1 Intended use

Referring to the Installation and Maintenance Instructions, name-plate and Technical Information Sheet, check that the product is suitable for the intended use or application.

## 1.2 Access

Ensure safe access and if necessary a safe working platform (suitably guarded) before attempting to work on the product. Arrange suitable lifting gear if required.

## 1.3 Lighting

Ensure adequate lighting, particularly where detailed or intricate work is required.

## 1.4 Hazardous liquids or gases in the pipeline

Consider what is in the pipeline or what may have been in the pipeline at some previous time. Consider: flammable materials, substances hazardous to health, extremes of temperature.

## 1.5 Hazardous environment around the product

Consider: explosion risk areas, lack of oxygen (e.g. tanks, pits), dangerous gases, extremes of temperature, hot surfaces, fire hazard (e.g. during welding), excessive noise, moving machinery.

## 1.6 The system

Consider the effect on the complete system of the work proposed. Will any proposed action (e.g. closing isolation valves, electrical isolation) put any other part of the system or any personnel at risk? Dangers might include isolation of vents or protective devices or the rendering ineffective of controls or alarms. Ensure isolation valves are turned on and off in a gradual way to avoid system shocks.

## **1.7 Pressure systems**

Ensure that any pressure is isolated and safely vented to atmospheric pressure. Consider double isolation (double block and bleed) and the locking or labelling of closed valves. Do not assume that the system has depressurized even when the pressure gauge indicates zero.

## **1.8 Temperature**

Allow time for temperature to normalize after isolation to avoid the danger of burns and consider whether protective clothing (including safety glasses) is required.

## **1.9 Tools and consumables**

Before starting work ensure that you have suitable tools and / or consumables available. Use only genuine Spirax Sarco replacement parts.

## **1.10 Protective clothing**

Consider whether you and /or others in the vicinity require any protective clothing to protect against the hazards of, for example, chemicals, high / low temperature, radiation, noise, falling objects, and dangers to eyes and face.

## **1.11 Permits to work**

All work must be carried out or be supervised by a suitably competent person. Installation and operating personnel should be trained in the correct use of the product according to the Installation and Maintenance Instructions. Where a formal 'permit to work' system is in force it must be complied with. Where there is no such system, it is recommended that a responsible person should know what work is going on and, where necessary, arrange to have an assistant whose primary responsibility is safety. Post 'warning notices' if necessary.

## **1.12 Handling**

Manual handling of large and /or heavy products may present a risk of injury. Lifting, pushing, pulling, carrying or supporting a load by bodily force can cause injury particularly to the back. You are advised to assess the risks taking into account the task, the individual, the load and the working environment and use the appropriate handling method depending on the circumstances of the work being done.

## **1.13 Residual hazards**

In normal use the external surface of the product may be very hot. Take due care when dismantling or removing the product from an installation.

## **1.14 Freezing**

Provision must be made to protect products which are not self-draining against frost damage in environments where they may be exposed to temperatures below freezing point.

## **1.15 Disposal**

Unless otherwise stated in the Installation and Maintenance Instructions, this product is recyclable and no ecological hazard is anticipated with its disposal providing due care is taken.

## 2. Introduction

### 2.1 General

The UTM10 Series of ultrasonic flow meters are designed to measure the fluid velocity of liquid within a closed conduit. The transducers are a non-contacting, clamp-on type or clamp-around, which will provide benefits of non-fouling operation and ease of installation.

The UTM10 Series of transit-time flow meters utilize two transducers that function as both ultrasonic transmitters and receivers. The transducers are clamped on the outside of a closed pipe at a specific distance from each other. The transducers can be mounted in V-mount where the sound transverses the pipe two times, W-mount where the sound transverses the pipe four times, or in Z-mount where the transducers are mounted on opposite sides of the pipe and the sound crosses the pipe once. The selection of mounting method is based on pipe and liquid characteristics which both have an effect on how much signal is generated. The flow meter operates by alternately transmitting and receiving a frequency modulated burst of sound energy between the two transducers and measuring the time interval that it takes for sound to travel between the two transducers. The difference in the time interval measured is directly related to the velocity of the liquid in the pipe.

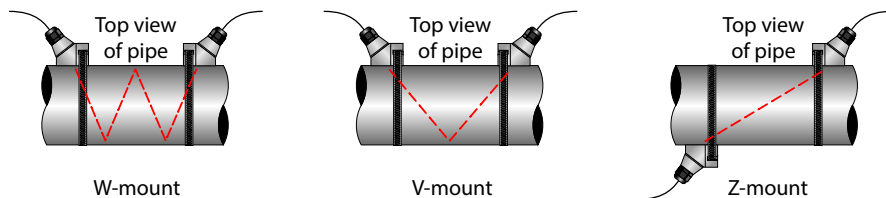

Fig. 1 Transducer mounting configurations

### 2.2 Application versatility

The UTM10 flow meter can be successfully applied on a wide range of metering applications. The simple-to-program transmitter allows the standard product to be used on pipe sizes ranging from 12 mm to 2540 mm ( $\frac{1}{2}$ " to 100").

**Please note** that 12 mm to 40 mm ( $\frac{1}{2}$ " to 1 $\frac{1}{2}$ ") transducer sets require the transmitter be configured for 2 MHz and use dedicated pipe transducers. UTT10-050L transducers require the use of the 500 KHz transmission frequency. The transmission frequency is selectable using either the software utility or the Transmitter's Keypad.

**A variety of liquid applications can be accommodated:**

- Ultrapure liquids
- Cooling water
- Potable water
- River water
- Chemicals
- Plant effluent
- Sewage
- Reclaimed water
- Others

Because the transducers are non-contacting and have no moving parts, the flow meter is not affected by system pressure, fouling or wear:

- **UTT10-050S** and **UTT10-050L** (Standard transducers) are rated to a pipe surface temperature of -40 to +90°C (-40 to +194°F).
- **UTT10-050H** high temperature transducers can operate to a pipe surface temperature of -40 to +176°C (-40 to +350°F).
- **UTT10-015S** to **UTT10-040S** small pipe transducers will withstand temperature of -40 to +90°C (-40 to +194°F).

## 2.3 CE compliance

The UTM10 transmitter can be installed in conformance to EN 55011 (CISPR 11) standards. See "9.8 CE compliance drawings" on page 113 .

## 2.4 User safety

The UTM10 employs modular construction and provides electrical safety for the operator. The display face contains voltages no greater than 28 Vdc. The display face swings open to allow access to user connections.



**WARNING:**

**Disconnect the electrical power supply before opening the instrument enclosure. Wiring should always conform to local codes and the National Electrical Code®.**

## 2.5 Data integrity

Non-volatile flash memory retains all user-entered configuration values in memory for several years at 25°C (77°F), even if power is lost or turned off. Password protection is provided as part of the Security menu (SEC MENU) and prevents inadvertent configuration changes or totalizer resets.

## 2.6 Product identification

The serial number and complete model number of the transmitter are located on the top outside surface of the transmitter's body. Should technical assistance be required, please provide the Customer Service Department with this information.

# 3. Transmitter installation

## 3.1 General information

After unpacking the UTM10, it is recommended that its shipping carton and packing materials be saved in case the instrument needs to be stored or re-shipped to a different location. Inspect the equipment and carton for damage. If there is evidence of shipping damage, notify the carrier immediately.

The enclosure should be mounted in an area that is convenient for servicing, calibration or for observation of the LCD readout.

- 1) Locate the transmitter within the length of transducer cables supplied.
- 2) Mount the UTM10 transmitter in a location:
  - Where little vibration exists.
  - That is protected from corrosive fluids.
  - That is within the transmitters ambient temperature limits -40 to +85°C (-40 to +185°F) or -40 to 55°C (-40 to 131°F) for line AC with Ethernet.
  - That is out of direct sunlight. Direct sunlight may increase transmitter temperature to above the maximum limit.
- 3) **Mounting** - Refer to *Fig. 2* for enclosure and mounting dimension details. Ensure that enough room is available to allow for door swing, maintenance and conduit entrances. Secure the enclosure to a flat surface with two appropriate fasteners.
- 4) **Conduit holes** - Conduit holes should be used where cables enter the enclosure. Holes not used for cable entry should be sealed with plugs.

An optional cable gland kit is available for inserting transducer and power cables. The part number for this kit is D010-1100-000 and can be ordered directly from the manufacturer.

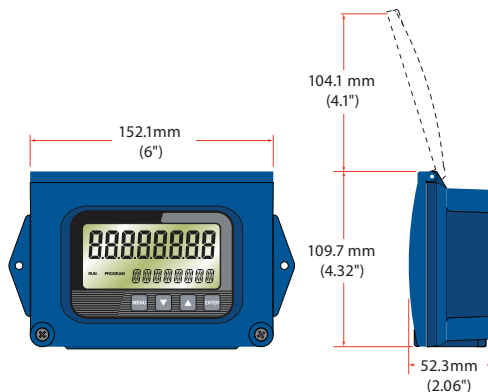

**Fig. 2 UTM10 transmitter dimensions**

**Note:** Use IP65 (NEMA 4) rated fittings/plugs to maintain the watertight integrity of the enclosure. Generally, the right conduit hole (viewed from front) is used for power, the left conduit hole for transducer connections, and the center hole is utilized for I/O wiring.



## 3.2 Transducer connections

To access terminal strips for wiring, loosen the two screws in the enclosure door and open. Guide the transducer terminations through the transmitter conduit hole located in the bottom-left of the enclosure. Secure the transducer cable with the supplied conduit nut (if flexible conduit was ordered with the transducer).

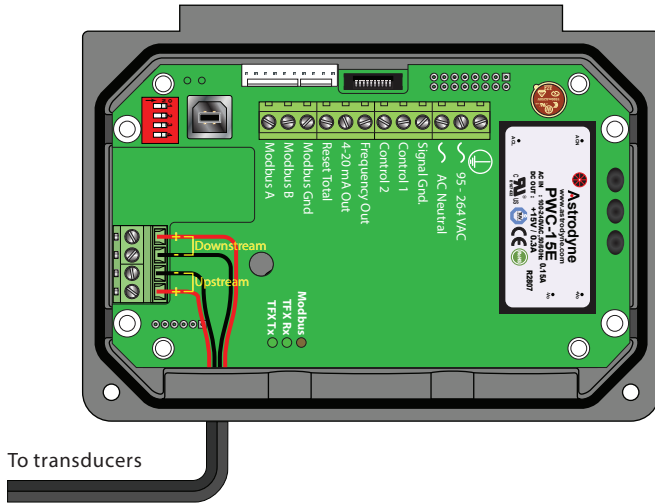

**Fig. 3 Transducer connections**

The terminals within the UTM10 are of a screw-down barrier terminal type. Connect the appropriate wires at the corresponding screw terminals in the transmitter. Observe upstream and downstream (+/-) orientation. See *Fig. 3*.

**Note:** The transducer cable carries low level, high frequency signals. In general, it is not recommended to add additional length to the cable supplied with the transducer. If additional cable is required, contact the manufacturer to arrange an exchange for a transducer with the appropriate length of cable. Cables to 300 metres (990 feet) are available. If additional cable is added, ensure that it is RG59 75 Ohm compatible and uses BNC terminations.

Connect power to the screw terminal block in the UTM10 transmitter. See *Fig. 4 on page 14* and *Fig. 5 on page 15*. Utilize the conduit hole on the right side of the enclosure for this purpose. Use wiring practices that conform to local and National codes (e.g., The National Electrical Code® Handbook in the U.S.).



**Caution:** Any other wiring method may be unsafe or cause improper operation of the instrument.

**Note:** This instrument requires clean electrical line power. Do not operate this unit on circuits with noisy components (i.e., fluorescent lights, relays, compressors, or variable frequency drives). The use of step down transformers from high voltage, high amperage sources is also not recommended. Do not run signal wires with line power within the same wiring tray or conduit.

### 3.3 Line voltage ac power connections

Connect 90 to 265 Vac, ac Neutral and Chassis Ground to the terminals referenced in Fig. 4. Do not operate without an earth (chassis) ground connection.

#### IMPORTANT

Permanently connected equipment and multi-phase equipment uses a switch or circuit breaker as a means of disconnect. The switch or circuit breaker conforms to the following:

- A switch or circuit breaker is included in the building installation.
- The switch is in close proximity to the equipment and within easy reach of the operator.
- The switch is marked as the disconnecting device for the equipment.

Wiring of this equipment in ordinary locations must be in accordance with ANSI/NFPA 70, National Electrical Code (NEC), Canadian Electrical Code (CEC) or IEC 60364 as required by local codes. Wiring of this equipment in hazardous locations requires special considerations such as those described in National Electrical Code (NEC) Article 500, Canadian Electrical Code (CEC), CSA C22.1 or IEC 60079-14.

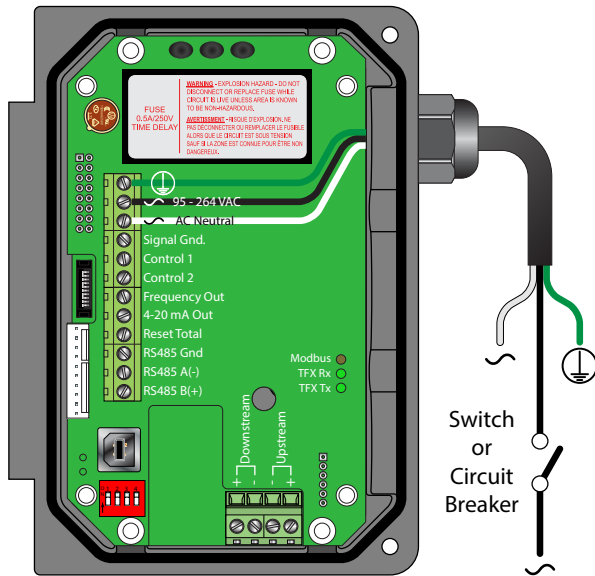

Fig. 4 ac power connections

### 3.4 Low voltage ac power connections

Connect 20 to 26 Vac, ac Neutral and Chassis Ground to the terminals referenced in Fig. 5.



**Danger!** Do not operate without an earth (chassis) ground connection.

The 24 Vac power supply option for the UTM10 is intended for a typical HVAC and Building Control Systems (BCS) powered by a 24 Vac, nominal, power source. This power source is provided by ac line power to 24 Vac drop down transformer and is installed by the installation electricians.

**Note:** In electrically noisy applications, grounding the flow meter to the pipe where the transducers are mounted may provide additional noise suppression. This approach is only effective with conductive metal pipes. The earth (chassis) ground derived from the line voltage power supply should be removed at the flow meter and a new earth ground connected between the flow meter and the pipe being measured.

**Note:** Wire gauges up to 2.08 mm<sup>2</sup> (14 AWG) can be accommodated in the UTM10 terminal block.

**Note:** ac powered versions are protected by a field replaceable fuse, P.N. D005-1301-012. This fuse is equivalent to Wickmann P.N. 3720500041 or 37405000410.

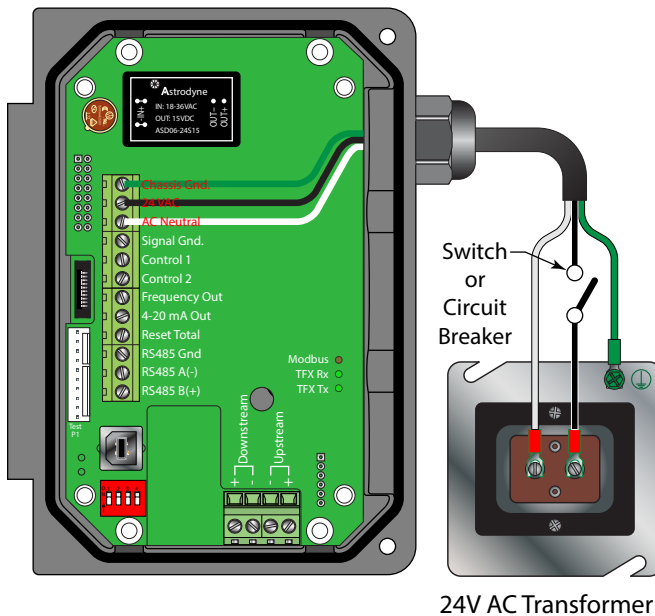

Fig. 5 24 Vac power connections

### 3.5 dc power connections

The UTM10 may be operated from a 10 to 28 Vdc source, as long as the source is capable of supplying a minimum of 5 Watts of power.

Connect the dc power to the 10 to 28 Vdc In, Power Ground, and Chassis Ground, as in Fig. 6. For CE compliance, a Class 2 dc power supply is required.

**Note:** dc powered versions are protected by an automatically resetting fuse. This fuse does not require replacement.

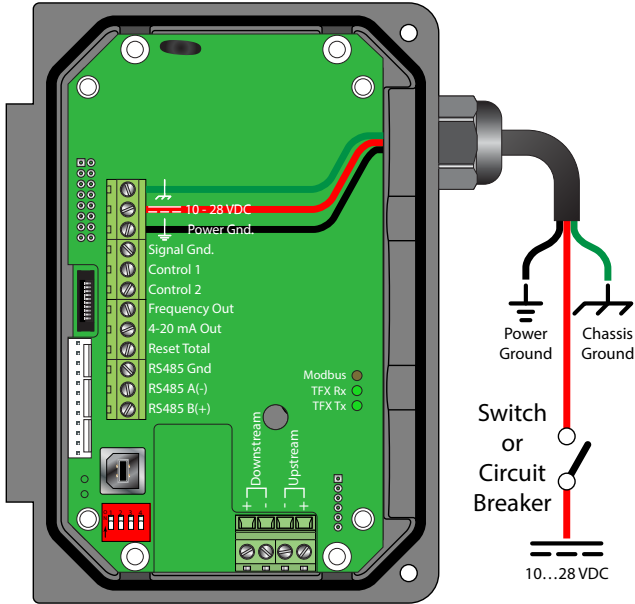

Fig. 6 dc power connections

# 4. Transducer installation

## 4.1 General

The transducers that are utilized by the UTM10 contain piezoelectric crystals for transmitting and receiving ultrasonic signals through walls of liquid piping systems. The UTT10-050S, UTT10-050L, and UTT10-050H transducers are relatively simple and straightforward to install, but spacing and alignment of the transducers is critical to the system's accuracy and performance. Extra care should be taken to ensure that these instructions are carefully executed. UTT10-015S to UTT10-040S, small pipe transducers, have integrated transmitter and receiver elements that eliminate the requirement for spacing measurement and alignment.

Mounting of the UTT10-05S, UTT10-050L, and UTT10-050H clamp-on ultrasonic transit-time transducers is comprised of these steps:

- 1) Selection of the optimum location on a piping system.
- 2) Select a mounting configuration.
- 3) Entering the pipe and liquid parameters into either the software utility or keying the parameters into the transmitter using the keypad. The software utility or the transmitters firmware will calculate proper transducer spacing based on these entries.
- 4) Pipe preparation and transducer mounting.
- 5) Wire the transducers to the transmitter.

The UTM10-E transmitter requires two RTDs to measure heat usage. The flow meter utilizes 1000 Ohm, three-wire, platinum RTDs in two mounting styles. Surface mount RTDs are available for use on well insulated pipes. If the area where the RTD will be located is not insulated, inconsistent temperature readings will result and insertion (wetted) RTDs should be utilized.

## 4.2 Step 1 - Mounting location

The first step in the installation process is the selection of an optimum location for the flow measurement to be made. For this to be done effectively, a basic knowledge of the piping system and its plumbing are required.

An optimum location is defined as:

- A piping system that is completely full of liquid when measurements are being taken. The pipe may become completely empty during a process cycle – which will result in the error code 0010 (Low Signal Strength) being displayed on the flow meter while the pipe is empty. This error code will clear automatically once the pipe refills with liquid. It is not recommended to mount the transducers in an area where the pipe may become partially filled. Partially filled pipes will cause erroneous and unpredictable operation of the flow meter.
- A piping system that contains lengths of straight pipe such as those described in Table 1. The optimum straight pipe diameter recommendations apply to pipes in both horizontal and vertical orientation. The straight runs in "Table 1 Piping configuration and transducer positioning" on page 18 apply to liquid velocities that are nominally 2.2 m/s (7 ft/s). As liquid velocity increases above this nominal rate, the requirement for straight pipe increases proportionally.
- Mount the transducers in an area where they will not be inadvertently bumped or disturbed during normal operation.
- Avoid installations on downward flowing pipes unless adequate downstream head pressure is present to overcome partial filling of or cavitation in the pipe.

**Table 1 Piping configuration and transducer positioning**

The flow meter system will provide repeatable measurements on piping systems that do not meet these requirements, but accuracy of these readings may be influenced to various degrees.

Piping configuration and transducer positioning	Upstream pipe diameters	Downstream pipe diameters
	A	B
	30	5
	15	5
	10	5
	10	5
	10	5
	30	5

### 4.3 Step 2 - Transducer spacing

UTM10 transit-time flow meters can be used with four different transducer types: UTT10-050S, UTT10-050L, UTT10-050H and UTT10-015S to UTT10-040S. Flowmeters that utilize the UTT10-05S, UTT10-050L, or UTT10-050H transducer sets consist of two separate sensors that function as both ultrasonic transmitters and receivers. UTT10-015S to UTT10-040S transducers integrate both the transmitter and receiver into one assembly that fixes the separation of the piezoelectric crystals. UTT10-050S, UTT10-050L and UTT10-050H transducers are clamped on the outside of a closed pipe at a specific distance from each other.

The UTT10-050S, UTT10-050L and UTT10-050H transducers can be mounted in:

- **W-mount** where the sound traverses the pipe four times. This mounting method produces the best relative travel time values but the weakest signal strength.
- **V-mount** where the sound traverses the pipe twice. V-mount is a compromise between travel time and signal strength.
- **Z-mount** where the transducers are mounted on opposite sides of the pipe and the sound crosses the pipe once. Z-mount will yield the best signal strength but the smallest relative travel time.

**Table 2 Transducer mounting modes – UTT10-050S, UTT10-050L and UTT10-050H**

Transducer mount mode	Pipe material	Pipe size	Liquid composition
<b>W-mount</b>	Plastic (all types)	50 - 100 mm (2" - 4")	Low TSS (Total Suspended Solids); non-aerated
	Carbon steel		
	Stainless steel		
	Copper	Not recommended	
	Ductile iron		
	Cast iron		
<b>V-mount</b>	Plastic (all types)	100 - 300 mm (4" - 12")	Low TSS (Total Suspended Solids); non-aerated
	Carbon steel		
	Stainless steel		
	Copper	100 - 750 mm (4" - 30")	
	Ductile iron	50 - 300 mm (2" - 12")	
	Cast iron		
<b>Z-mount</b>	Plastic (all types)	>750 mm (>30")	Low TSS (Total Suspended Solids); non-aerated
	Carbon steel	>300 mm (>12")	
	Stainless steel		
	Copper	>750 mm (>30")	
	Ductile iron	>300 mm (>12")	
	Cast iron		

For further details, reference Fig. 7. The appropriate mounting configuration is based on pipe and liquid characteristics. Selection of the proper transducer mounting method is not entirely predictable and many times is an iterative process. Table 2 contains recommended mounting configurations for common applications. These recommended configurations may need to be modified for specific applications if such things as aeration, suspended solids, out of round piping or poor piping conditions are present. Use of the UTM10 diagnostics in determining the optimum transducer mounting is covered later in this Section.

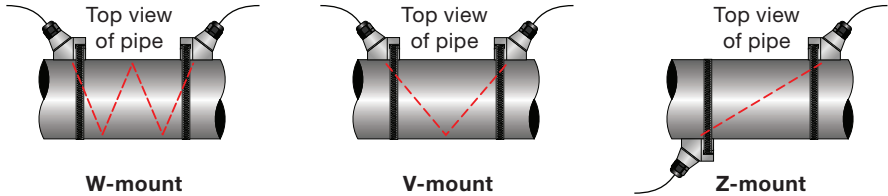

Fig. 7 Transducer mounting modes – UTT10-050S, UTT10-050L and UTT10-050H

**Table 3 Transducer mounting modes – UTT10-015S to UTT10-040S**

Size	Frequency setting	Transducer	Mounting mode
15 mm (½")	2 MHz	UTT10-015SM	<b>V</b>
		UTT10-015SC	
		UTT10-015SP	
20 mm (¾")	2 MHz	UTT10-020SM	
		UTT10-020SC	
		UTT10-020P	
25 mm (1")	2 MHz	UTT10-025SM	
		UTT10-025SC	
		UTT10-025P	
32 mm (1¼")	2 MHz	UTT10-032SM	
		UTT10-032SC	
		UTT10-032SP	
40 mm (1½")	2 MHz	UTT10-040SM	
		UTT10-040SC	
		UTT10-040SP	

For pipe sizes of 600 mm (24") and larger the UTT10-050L transducer using a transmission frequency of 500 KHz is recommended.

The UTT10-050L transducer may also be advantageous on pipes of between 100 - 600 mm (4" - 24") if there are less quantifiable complicating aspects such as – sludge, tuberculation, scale, rubber liners, plastic liners, thick mortar, gas bubbles, suspended solids, emulsions, or pipes that are perhaps partially buried where a V-mount is required / desired, etc.



## 4.4 Step 3 - Entering pipe and liquid data

The UTM10 system calculates proper transducer spacing by utilizing piping and liquid information entered by the user. This information can be entered via the keypad on a UTM10 or via the optional software utility.

The best accuracy is achieved when transducer spacing is exactly what the UTM10 calculates, so the calculated spacing should be used if signal strength is satisfactory. If the pipe is not round, the wall thickness not correct or the actual liquid being measured has a different sound speed than the liquid programmed into the transmitter, the spacing can vary from the calculated value. If that is the case, the transducers should be placed at the highest signal level observed by moving the transducers slowly around the mount area.

**Note:** Transducer spacing is calculated on 'ideal' pipe. Ideal pipe is almost never found so the transducer spacing distances may need to be altered. An effective way to maximize signal strength is to configure the display to show signal strength, fix one transducer on the pipe and then starting at the calculated spacing, move the remaining transducer small distances forward and back to find the maximum signal strength point.

Important! Enter all of the data on this list, save the data and reset the UTM10 before mounting transducers.

The following information is required before programming the instrument:

Transducer mounting configuration	Pipe O.D. (outside diameter)
Pipe wall thickness	Pipe material
Pipe sound speed*	Pipe relative roughness*
Pipe liner thickness (if present)	Pipe liner material (if present)
Fluid type	Fluid sound speed*
Fluid viscosity*	Fluid specific gravity*

**Note:** Much of the data relating to material sound speed, viscosity and specific gravity is pre-programmed into the UTM10 flow meter. This data only needs to be modified if it is known that a particular application's data varies from the reference values. Refer to "7. Start-up and Configuration" on page 46 for instructions on entering configuration data into the UTM10 flow meter via the transmitter's keypad. Refer to Section 8 'Software utility' for data entry via the software.

\* Nominal values for these parameters are included within the UTM10 operating system. The nominal values may be used as they appear or may be modified if exact system values are known.

After entering the data listed above, the UTM10 will calculate proper transducer spacing for the particular data set. This distance will be in millimetres if configured in metric units or inches if the UTM10 is configured in imperial units.

## 4.5 Step 4 - Transducer mounting

### 4.5.1 Pipe preparation

After selecting an optimal mounting location ("*Step 1 - Mounting location*" on page 17) and successfully determining the proper transducer spacing ("*Step 2 - Transducer spacing*" on page 19 and "*Step 3 - Entering pipe and liquid data*" on page 21), the transducers may now be mounted onto the pipe, which is covered in this section.

Before a transducer is mounted onto the pipe surface, an area slightly larger than the flat surface of each transducer must be cleaned of all rust, scale and moisture. For pipes with rough surfaces, such as ductile iron pipe, it is recommended that the pipe surface be wire brushed to a shiny finish. Paint and other coatings, if not flaked or bubbled, need not be removed. Plastic pipes typically do not require surface preparation other than soap and water cleaning.

The UTT10-050S, UTT10-050L and UTT10-050H transducers must be properly oriented and spaced on the pipe to provide optimum reliability and performance. On horizontal pipes, when Z-mount is required, the transducers should be mounted 180° from one another and at least 45° from the top-dead-center and bottom-dead-center of the pipe. See Fig. 8. Also see "*Mounting transducers in Z-mount configuration*" on page 28. On vertical pipes the orientation is not critical.

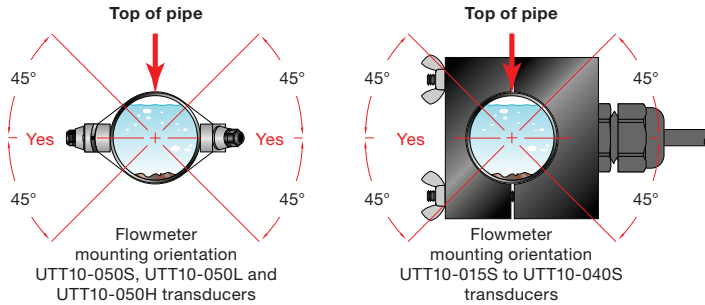

**Fig. 8 Transducer orientation — Horizontal pipes**

The spacing between the transducers is measured between the two spacing marks on the sides of the transducers. These marks are approximately 19 mm (0.75") back from the nose of the UTT10-050S and UTT10-050H transducers, and 30 mm (1.2") back from the nose of the UTT10-050L transducers. See Fig. 9.

UTT10-015S to UTT10-040S transducers should be mounted with the cable exiting within  $\pm 45^\circ$  of the side of a horizontal pipe. See Fig. 8. On vertical pipes the orientation does not apply.

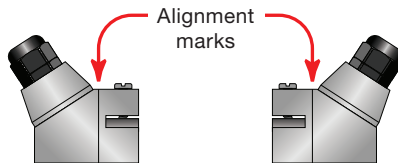

**Fig. 9 Transducer alignment marks**

## 4.6 V-mount and W-mount installation

### 4.6.1 Application of couplant

For UTT10-050S, UTT10-050L and UTT10-050H transducers, place a single bead of couplant, approximately 12 mm (½") thick, on the flat face of the transducer. See Figure 10. Generally, a silicone-based grease is used as an acoustic couplant, but any grease-like substance that is rated not to 'flow' at the temperature that the pipe may operate at will be acceptable. For pipe surface temperature over 55°C (130°F), Krytox® LVP (P.N. D002-2011-012) is recommended.

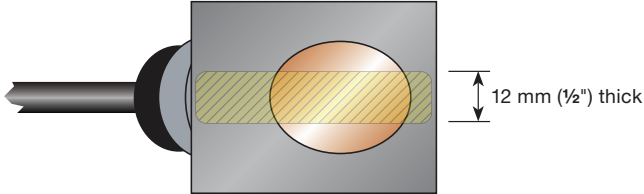

Fig. 10 Application of couplant

### 4.6.2 Transducer positioning

- 1) Place the upstream transducer in position and secure with a mounting strap. Straps should be placed in the arched groove on the end of the transducer. A screw is provided to help hold the transducer onto the strap. Verify that the transducer is true to the pipe and adjust as necessary. Tighten the transducer strap securely.
- 2) Place the downstream transducer on the pipe at the calculated transducer spacing (Fig. 11 on page 24). See "Quick-start operating instructions" on page 43. By applying firm hand pressure, test to see if the signal strength is greater than 5. If it is, secure the transducer at this location. If the signal strength is not 5 or greater, use firm hand pressure and slowly move the transducer both towards and away from the upstream transducer while observing signal strength.

**Note:** Signal strength readings update only every few seconds, so it is advisable to move the transducer ¼", wait, see if signal is increasing or decreasing and then repeat until the highest level is achieved.

Signal strength can be displayed on the UTM10 display or on the main data screen in the software utility. See "Software utility" on page 70. Clamp the transducer at the position where the highest signal strength is observed. The factory default signal strength setting is 5, however there are many application specific conditions that may prevent the signal strength from attaining this level. For the UTM10, signal levels much less than 5 will probably not be acceptable for reliable readings.

- 3) If after adjustment of the transducer the signal strength does not rise above 5, then an alternate transducer mounting method should be selected. If the mounting method was W-mount, then re-configure the transmitter for V-mount, move the downstream transducer to the new spacing distance and repeat "Step 4 - Transducer mounting" on page 22.

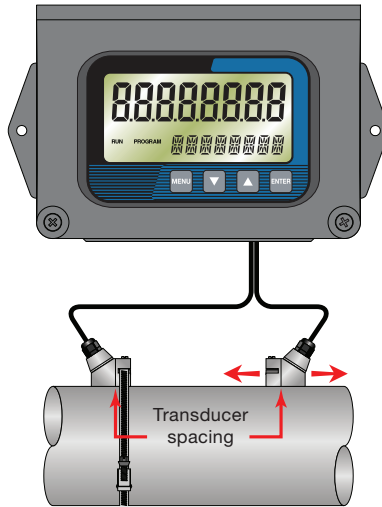

**Fig. 11 Transducer positioning**

**Note:** Mounting of high temperature transducers is similar to mounting the UTT10-050S and UTT10-050L transducers. High temperature installations require acoustic couplant that is rated not to 'flow' at the temperature that will be present on the pipe surface.

**Note:** As a rule, the UTT10-050L should be used on pipes 600 mm (24") and larger and not used for application on a pipe smaller than 100 mm (4"). Consider the application of a UTT10-050L transducer on a pipe smaller than 600 mm (24") if there are less quantifiable aspects such as - sludge, tuberculation, scale, rubber liners, plastic liners, thick mortar liners, gas bubbles, suspended solids, emulsions, and a smaller pipe that is perhaps partially buried where a V-mount is required / desired, etc.

## 4.7 UTT10 small pipe transducer installation

### 4.7.1 UTT10-015S to UTT10-040S small pipe transducer installation

The small pipe transducers are designed for specific pipe outside diameters. Do not attempt to mount a UTT10-015S to UTT10-040S transducer onto a pipe that is either too large or too small for the transducer. Contact the manufacturer to arrange for a replacement transducer that is the correct size.

**UTT10-015S to UTT10-040S installation consists of the following steps:**

- 1) Apply a thin coating of acoustic coupling grease to both halves of the transducer housing where the housing will contact the pipe. See *Fig. 12*.
- 2) On horizontal pipes, mount the transducer in an orientation such that the cable exits at  $\pm 45^\circ$  from the side of the pipe. Do not mount with the cable exiting on either the top or bottom of the pipe. On vertical pipes the orientation does not matter. See *Fig. 8* on page 22.
- 3) Tighten the wing nuts so that the acoustic coupling grease begins to flow out from the edges of the transducer or from the gap between the transducer halves. Do not over tighten.
- 4) If signal strength is less than 5, remount the transducer at another location on the piping system.

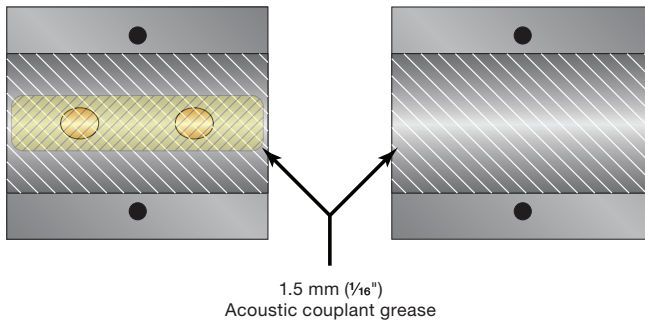

**Fig. 12 Application of acoustic couplant – UTT10-015S to UTT10-040S transducers**

**Note:** If a UTT10-015S to UTT10-040S small pipe transducer was purchased separately from the UTM10 flow meter, the following configuration procedure is required. See "*UTT10-015S to UTT10-040S small pipe transducer configuration procedure*" on page 26.

### 4.7.2 UTT10-015S to UTT10-040S small pipe transducer configuration procedure

- 1) Establish communications with the transit-time flow meter. See "Software utility" on page 70.
- 2) From the Tool Bar select Calibration. See Fig. 13.
- 3) On the pop-up screen, click Next button twice to get to Page 3 of 3. See Fig. 14.
- 4) Click Edit.

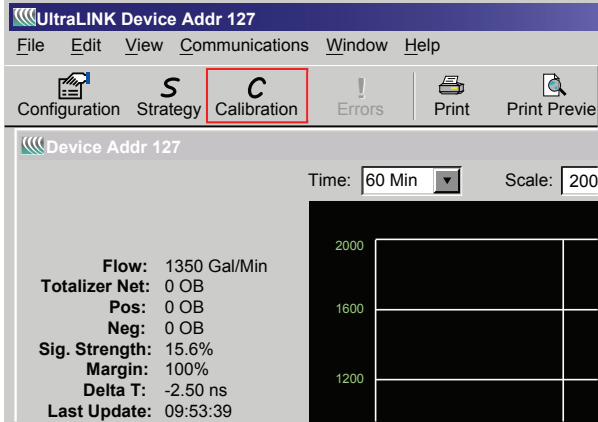

Fig. 13 Data display screen

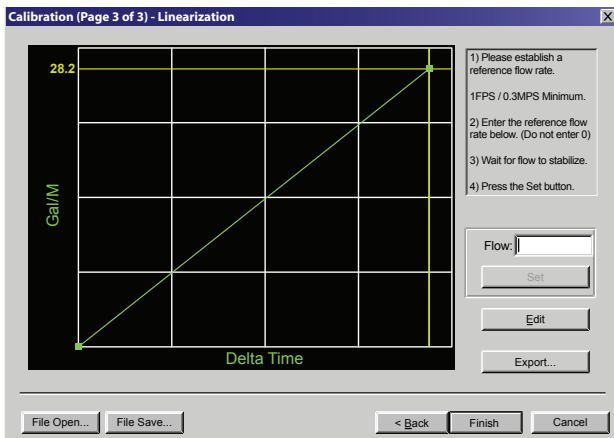
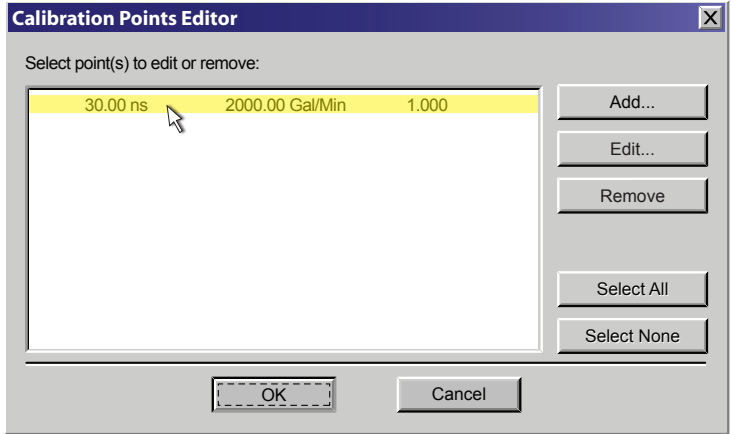
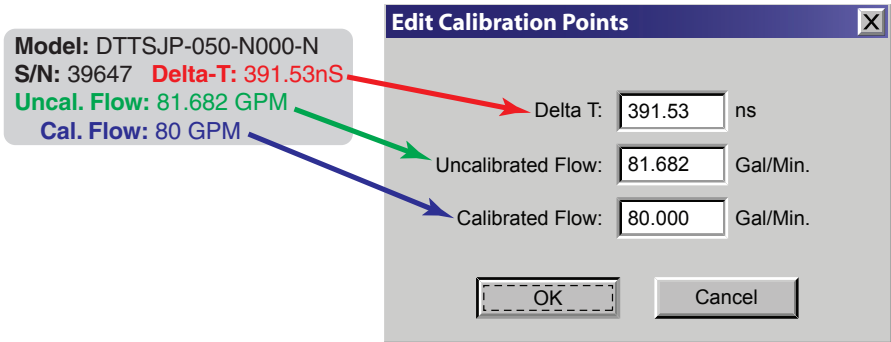

Fig. 14 Calibration (page 3 of 3)

- 5) If calibration point is displayed in Calibration Points Editor screen, record the information, highlight and click Remove. See Fig. 15.
- 6) Click ADD...



**Fig. 15 Calibration Points Editor**



**Fig. 16 Edit Calibration Points**

- 7) Enter Delta T, Uncalibrated Flow, and Calibrated Flow values from the UTT10-015S to UTT10-040S calibration label, then click OK. See Fig. 16.
- 8) Click OK in the Edit Calibration Points screen.
- 9) Process will return to Page 3 of 3. Click Finish. See Fig. 14 on page 26.
- 10) After 'Writing Configuration File' is complete, turn the power off. Turn the power back on to activate the new settings.

## 4.8 Mounting transducers in Z-mount configuration

Installation on larger pipes requires careful measurement of the linear and radial placement of the UTT10-050S, UTT10-050L and UTT10-050H transducers. Failure to properly orient and place the transducers on the pipe may lead to weak signal strength and/or inaccurate readings. This section details a method for properly locating the transducers on larger pipes. This method requires a roll of paper such as freezer paper or wrapping paper, masking tape and a marking device.

- 1) Wrap the paper around the pipe in the manner shown in *Fig. 17*. Align the paper ends to within 6 mm ( $\frac{1}{4}$ ").

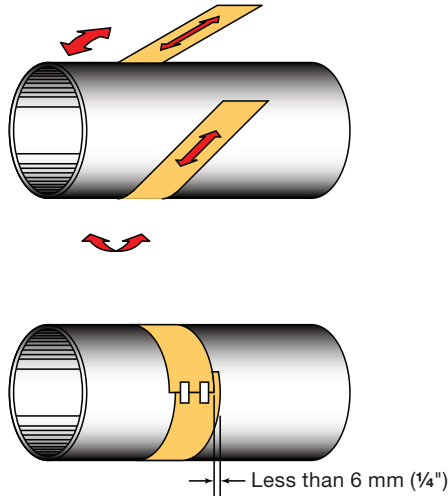

**Fig. 17 Paper template alignment**

- 2) Mark the intersection of the two ends of the paper to indicate the circumference. Remove the template and spread it out on a flat surface. Fold the template in half, bisecting the circumference. See *Fig. 18*.

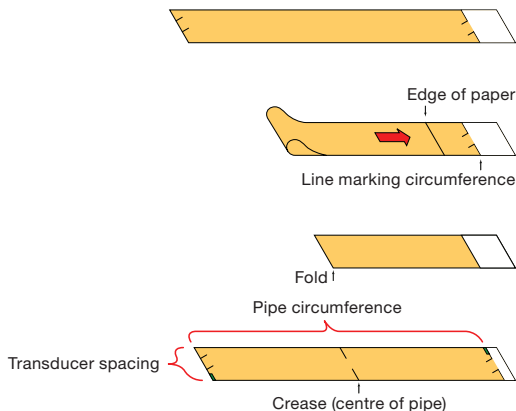

**Fig. 18 Bisecting the pipe circumference**



- 3) Crease the paper at the fold line. Mark the crease. Place a mark on the pipe where one of the transducers will be located. See Fig. 19 for acceptable radial orientations. Wrap the template back around the pipe, placing the beginning of the paper and one corner in the location of the mark. Move to the other side of the pipe and mark the pipe at the ends of the crease. Measure from the end of the crease (directly across the pipe from the first transducer location) the dimension derived in "Step 2 - Transducer spacing" on page 19. Mark this location on the pipe.

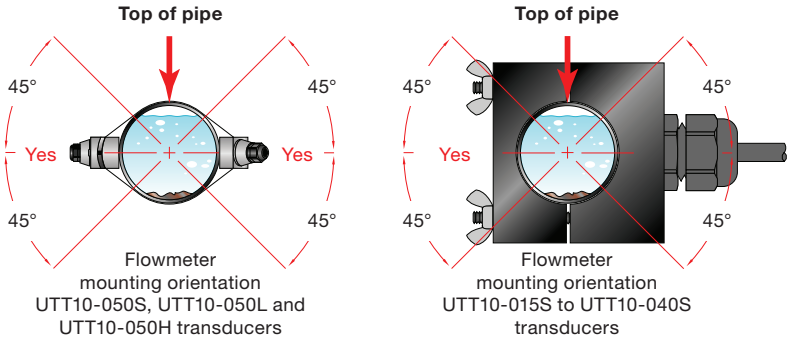

**Fig. 19 Transducer orientation – Horizontal pipes**

- 4) The two marks on the pipe are now properly aligned and measured. If access to the bottom of the pipe prohibits the wrapping of the paper around the circumference, cut a piece of paper 1/2 the circumference of the pipe and lay it over the top of the pipe. The length of 1/2 the circumference can be found by:

$$1/2 \text{ Circumference} = \text{Pipe O.D.} \times 1.57$$

See "Transducer positioning" on page 23 for transducer spacing.

Mark opposite corners of the paper on the pipe. Apply transducers to these two marks.

- 5) For UTT10-050S, UTT10-050L and UTT10-050H transducers, place a single bead of couplant, approximately 12 mm (1/2") thick, on the flat face of the transducer. See Fig. 20. Generally, a silicone-based grease is used as an acoustic couplant, but any good quality grease-like substance that is rated to not 'flow' at the temperature that the pipe may operate at will be acceptable.

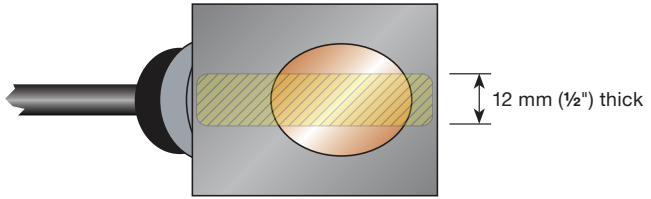
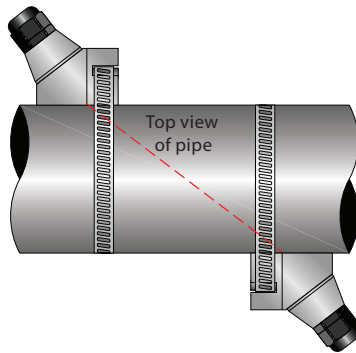

**Fig. 20 Application of couplant**

- 6) Place the upstream transducer in position and secure with a stainless steel strap or other fastening device. Straps should be placed in the arched groove on the end of the transducer. A screw is provided to help hold the transducer onto the strap. Verify that the transducer is true to the pipe, adjust as necessary. Tighten transducer strap securely. Larger pipes may require more than one strap to reach the circumference of the pipe.
- 7) Place the downstream transducer on the pipe at the calculated transducer spacing. See *Fig. 21*. Using firm hand pressure, slowly move the transducer both towards and away from the upstream transducer while observing signal strength. Clamp the transducer at the position where the highest signal strength is observed. Signal strength of between 5 and 98 is acceptable. The factory default signal strength setting is 5, however there are many application specific conditions that may prevent the signal strength from attaining this level.

A minimum signal strength of 5 is acceptable as long as this signal level is maintained under all flow conditions.

On certain pipes, a slight twist to the transducer may cause signal strength to rise to acceptable levels.

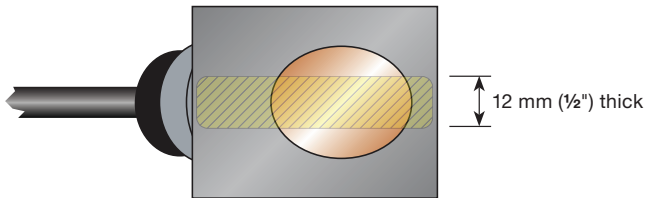

**Fig. 21 Z-mount transducer placement**

- 8) Certain pipe and liquid characteristics may cause signal strength to rise to greater than 98. The problem with operating a UTM10 with very high signal strength is that the signals may saturate the input amplifiers and cause erratic readings. Strategies for lowering signal strength would be changing the transducer mounting method to the next longest transmission path. For example, if there is excessive signal strength and the transducers are mounted in a Z-mount, try changing to V-mount or W-mount. Finally you can also move one transducer slightly off line with the other transducer to lower signal strength.
- 9) Secure the transducer with a stainless steel strap or other fastener.

## 4.9 Mounting rail and track installation

- 1) A convenient transducer mounting track can be used for pipes that have outside diameters between 50 and 250 mm (2" and 10"). If the pipe is outside of that range, select a V-mount or Z-mount mounting method.
- 2) Install the single mounting rail on the side of the pipe with the stainless steel bands provided. Do not mount it on the top or bottom of the pipe. Orientation on vertical pipe is not critical. Ensure that the track is parallel to the pipe and that all four mounting feet are touching the pipe.
- 3) Slide the two transducer clamp brackets towards the center mark on the mounting rail.
- 4) Place a single bead of couplant, approximately 12 mm (½") thick, on the flat face of the transducer. See *Fig. 22*.



**Fig. 22 Application of couplant**

- 5) Place the first transducer inbetween the mounting rails near the zero point on the scale. Slide the clamp over the transducer. Adjust the clamp/transducer such that the notch in the clamp aligns with zero on the scale. See *Fig. 23*.
- 6) Secure with the thumb screw. Ensure that the screw rests in the counter bore on the top of the transducer. (Excessive pressure is not required. Apply just enough pressure so that the couplant fills the gap between the pipe and transducer.)
- 7) Place the second transducer inbetween the mounting rails near the dimension derived in "Step 2 - Transducer spacing" on page 19. Read the dimension on the mounting rail scale. Slide the transducer clamp over the transducer and secure with the thumb screw.

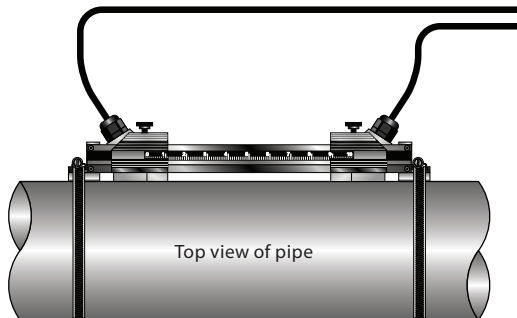

**Fig. 23 Mounting track installation**

# 5. Inputs and Outputs

## 5.1 General

The UTM10 is available configured as follows:

- 1) There is the UTM10-S flow model that is equipped with a 4-20 mA output, two open collector outputs, a rate frequency output, and RS485 communications using the Modbus RTU command set.
- 2) The energy version of the UTM10-E has inputs for two 1000 Ohm RTD sensors in place of the rate frequency and alarm outputs. This version allows the measurement of pipe input and output temperatures so that energy usage calculations can be performed.

## 5.2 4-20 mA output

The 4-20 mA output interfaces with most recording and logging systems by transmitting an analog current signal that is proportional to system flow rate. The 4-20 mA output is internally powered (current sourcing) and can span negative to positive flow/energy rates.

For ac powered units, the 4-20 mA output is driven from a +15 Vdc source located within the flow meter. The source is isolated from earth ground connections within the UTM10. The ac powered model can accommodate loop loads up to 400 Ohms. dc powered flow meters utilize the dc power supply voltage to drive the current loop. The current loop is not isolated from dc ground or power. Figure 24 illustrates graphically the allowable loads for various input voltages. The combination of input voltage and loop load must stay within the shaded area of Fig. 24.

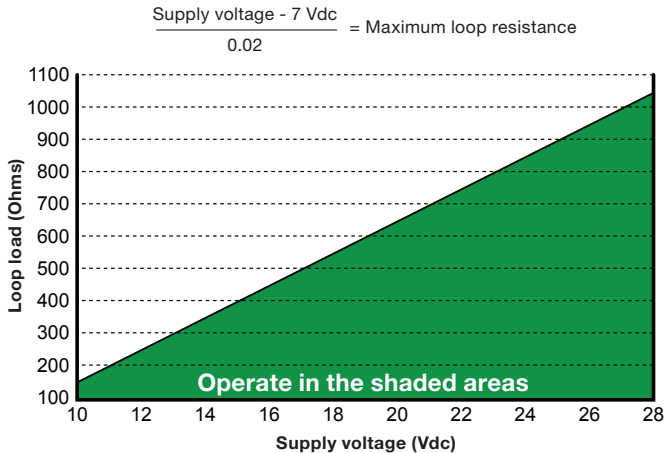
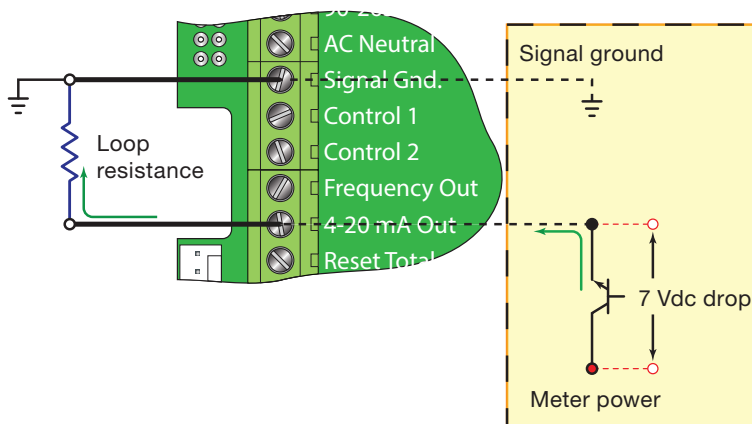

Fig. 24 Allowable loop resistance (dc powered units)



**Fig. 25 4-20 mA output**

The 4-20 mA output signal is available between the 4-20 mA out and Signal Gnd. terminals as shown in *Fig. 25*.

### 5.3 Control outputs UTM10-S only

Two independent open collector transistor outputs are included with the UTM10-S flow meter model. Each output can be configured for one of the following four functions:

- Rate Alarm
- Signal Strength Alarm
- Totalizing/Totalizing Pulse
- Errors
- None

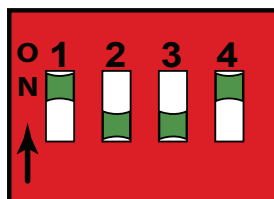

**Fig. 26 Switch settings**

Both control outputs are rated for a maximum of 100 mA and 10 to 28 Vdc. A pull-up resistor can be added externally or an internal 10 K Ohm pull-up resistor can be selected using DIP switches on the power supply board.

**Table 4 Dip switch functions**

Switch	S1	S2	S3	S4
<b>On</b>	Control 1 pull-up resistor IN circuit	Control 2 pull-up resistor IN circuit	Frequency output pull-up resistor IN circuit	Square wave output
<b>Off</b>	Control 1 pull-up resistor OUT of circuit	Control 2 pull-up resistor OUT of circuit	Frequency output pull-up resistor OUT of circuit	Simulated turbine output

For the Rate Alarm and Signal Strength Alarm, the on/off values are set using either the keypad of the software utility.

Typical control connections are illustrated in Fig. 27. Please note that only the Control 1 output is shown. Control 2 is identical except the pull-up resistor is governed by SW2.

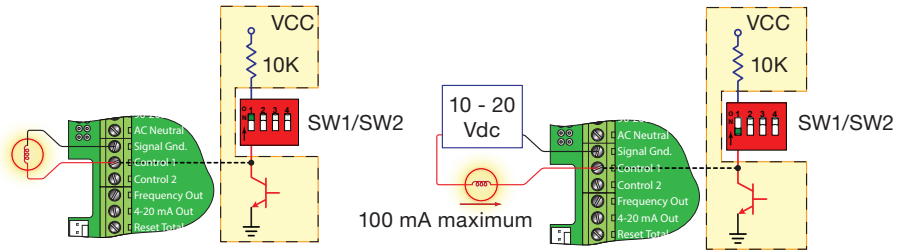

Fig. 27 Typical control connections

### 5.3.1 Alarm output

The flowrate output permits output changeover at two separate flowrates allowing operation with an adjustable switch deadband. Fig. 28 illustrates how the setting of the two setpoints influences rate alarm operation.

A single-point flowrate alarm would place the ON setting slightly higher than the OFF setting allowing a switch deadband to be established. If a deadband is not established, switch chatter (rapid switching) may result if the flowrate is very close to the switch point.

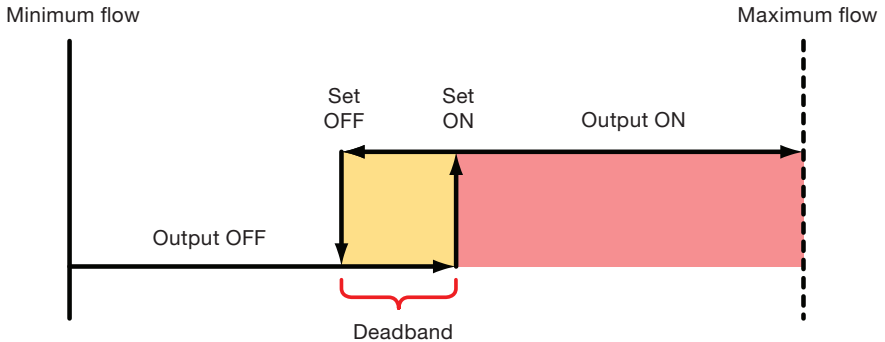

Fig. 28 Single point alarm option

### 5.3.2 Batch / totalizer output

Totalizer mode configures the output to send a 33 millisecond pulse each time the display totalizer increments divided by the TOT MULT. The TOT MULT value must be a whole, positive, numerical value.

For example, if the totalizer exponent (TOTL E) is set to E0 ( $\times 1$ ) and the totalizer multiplier (TOT MULT) is set to 1, then the output will pulse each time the totalizer increments one count, or each single, whole measurement unit totalized.

If the totalizer exponent (TOTL E) is set to E2 ( $\times 100$ ) and the totalizer multiplier (TOT MULT) is set to 1, then the control output will pulse each time the display totalizer increments or once per 100 measurement units totalized.

If the totalizer exponent (TOTL E) is set to E0 ( $\times 1$ ) and the totalizer multiplier (TOT MULT) is set to 2, the control output will pulse once for every two counts that the totalizer increments.

### 5.3.3 Signal strength alarm

The SIG STR alarm will provide an indication that the signal level reported by the transducers has fallen to a point where flow measurements may not be possible. It can also be used to indicate that the pipe has emptied. Like the rate alarm described previously, the signal strength alarm requires that two points be entered, establishing an alarm deadband. A valid switch point exists when the ON value is lower than the OFF value. If a deadband is not established and the signal strength decreases to approximately the value of the switch point, the output may 'chatter'.

### 5.3.4 Error alarm outputs

When a control output is set to ERROR mode, the output will activate when any error occurs in the flow meter that has caused the meter to stop measuring reliably. See the Appendix (Section 9) for a list of potential error codes.

## 5.4 Frequency output UTM10-S only

The frequency output is an open-collector transistor circuit that outputs a pulse waveform that varies proportionally with flowrate. This type of frequency output is also known as a 'Rate Pulse' output. The output spans from 0 Hz, normally at zero flowrate to 1000 Hz at full flowrate (configuration of the MAX RATE parameter is described in detail in Section 7 'Start-up and configuration').

The frequency output is proportional to the maximum flowrate entered into the flow meter. The maximum output frequency is 1000 Hz.

**Note:** When the USB programming cable is connected, the RS485 and frequency outputs are disabled.

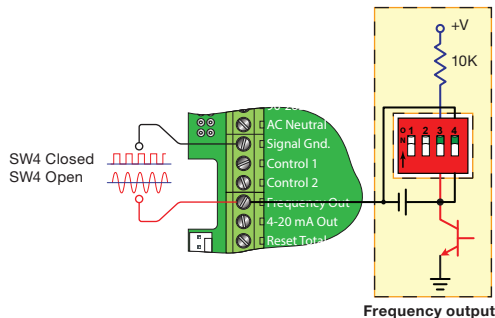

Fig. 29 Frequency output switch settings

If, for example, the MAX RATE parameter was set to 1514 litres/minute (400 US gallons/minute) then an output frequency of 500 Hz (half of the full-scale frequency of 1000 Hz) would represent 757 litres/minute (200 US gallons/minute).

In addition to the control outputs, the frequency output can be used to provide total information by use of a 'K-factor'. A K-factor simply relates the number of pulses from the frequency output to the number of accumulated pulses that equates to a specific volume.

For the UTM10 this relationship is described by the following equation. The 60 000 relates to measurement units in volume/min. Measurement units in seconds, hours or days would require a different numerator.

**Equation 1 K-factor calculation**       $K \text{ - factor} = \frac{60\,000}{\text{Full-scale units}}$

**Equation 1 K-factor calculation**

A practical example would be if the MAX RATE for the application were 400 GPM (Gallons/Minute), the K-factor (representing the number of pulses accumulated needed to equal 1 Gallon) would be:

$$K \text{ - factor} = \frac{60\,000}{400 \text{ GPM}} = 150 \text{ pulses per gallon}$$

If the frequency output is to be used as a totalizing output, the UTM10 and the receiving instrument must have identical K-factor values programmed into them to ensure that accurate readings are being recorded by the receiving instrument. Unlike standard mechanical flow meters such as turbines, gear or nutating disk meters, the K-factor can be changed by modifying the MAX RATE flowrate value.

**Note:** For a full treatment of K-factors, please see the "9.9 K-factors explained" on page 114.

**There are two frequency output types available:**

**Turbine meter simulation** - This option is utilized when a receiving instrument is capable of interfacing directly with a turbine flow meter's magnetic pickup. The output is a relatively low voltage ac signal whose amplitude swings above and below the signal ground reference. The minimum ac amplitude is approximately 500 mV peak-to-peak. To activate the turbine output circuit, turn SW4 OFF.

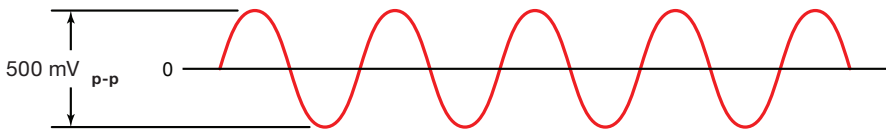

**Fig. 30 Frequency output waveform (simulated turbine)**

**Square-wave frequency** - This option is utilized when a receiving instrument requires that the pulse voltage level be either of a higher potential and/or referenced to dc ground. The output is a square-wave with a peak voltage equaling the instrument supply voltage when the SW3 is ON. If desired, an external pull-up resistor and power source can be utilized by leaving SW3 OFF. Set SW4 to ON for a square-wave output.

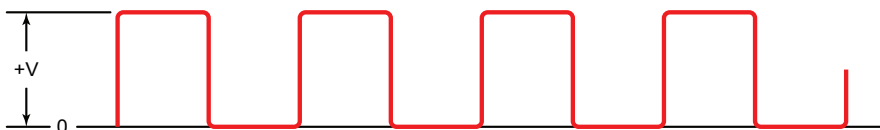

**Fig. 31 Frequency output waveform (square wave)**



## 5.5 Totalizer output (energy model)

Energy models can be ordered with a totalizer pulse output option. This option is installed in the position where the Ethernet option would normally be installed.

**Table 5 Optional totalizing pulse specifications**

Parameter	Specification
Signal	One pulse for each increment of the totalizer's least significant digit
Type	Opto-isolated, open collector transistor
Pulse Width	30 mSec, maximum pulse rate 16 Hz
Voltage	28 vdc maximum
Current	100 mA maximum (current sink)
Pullup Resistor	2.8 - 10 k Ohms

**Note:** The totalizer pulse output option and the Ethernet communications output cannot be installed in the same energy model at the same time.

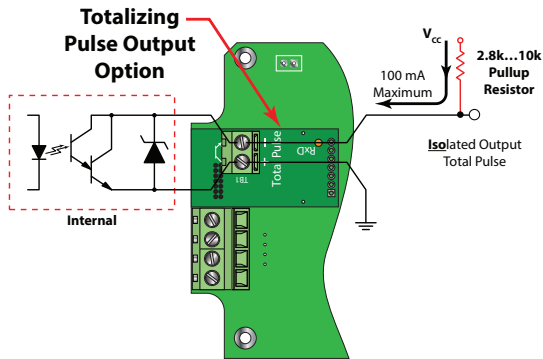

**Fig. 32 Energy model auxiliary totalizer output option**

Wiring and configuration of the Energy model is similar to the totalizing pulse output for the Flow-Only model. This option must use an external current limiting resistor.

## 5.6 RS485

The RS485 feature allows up to 126 UTM10 systems to be placed on a single three-wire cable bus. All flow meters are assigned a unique numeric address that allows all of the flow meters on the cable network to be independently accessed. A Modbus RTU command protocol is used to interrogate the flow meters. An explanation of the command structure is detailed in Section 9 'Appendix'. Flowrate, total, signal strength and temperature (if so equipped) can be monitored over the digital communications bus. Baud rates up to 9600 and cable lengths to 1500 m (5000 ft) are supported without repeaters or 'end of line' resistors.

To interconnect flow meters, utilize three-wire shielded cable such as Belden® 9939 or equal. In noisy environments the shield should be connected on one end to a good earth ground connection. A USB to RS485 converter such as the B&B Electronics P/N 485USBTB-2W can be used to communicate with a PC running Windows XP or Windows Vista®. For computers with RS232C serial ports, an RS232C to RS485 converter, such as B&B Electronics P/N 485SD9TB (illustrated in Fig. 34 on page 39), is required to interconnect the RS485 network to a communication port on a PC. If more than 126 flow meters must be monitored, an additional converter and communication port are required.

**Note:** When the USB programming cable is connected, the RS485 and frequency outputs are disabled.

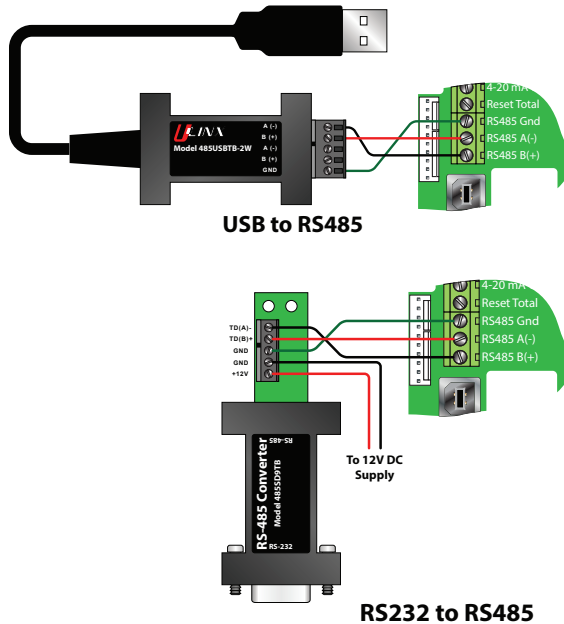

Fig. 33 RS485 network connections

## 5.7 Ethernet port

The Ethernet port is 10/100 Base T with an RJ connector and supports BACnet IP, Modbus TCP/IP and EtherNet/IP protocols. The Ethernet option must be ordered with the transmitter. For Energy models, the Ethernet option is not available with the Totalizing Pulse option.

## 5.8 USB programming port

The USB programming port is a USB 2.0 Type B connector similar to the USB port on many printers. The USB programming port on the transmitter is the cable connection point from a computer with UltraLink software. UltraLink is used for configuring, calibrating and troubleshooting the meter.

## 5.9 Energy flow UTM10-E only

The UTM10-E allows the integration of two 1000 Ohm, platinum RTDs with the flow meter, effectively providing an instrument for measuring energy consumed in liquid heating and cooling systems. If RTDs were ordered with the UTM10 flow meter, they have been factory calibrated and are shipped with the flow meter.

The energy flow meter has multiple heat ranges to choose from. For best resolution use the temperature range that encompasses the temperature range of the application.

The three-wire surface mount RTDs are attached at the factory to a simple plug-in connector eliminating the possibility of mis-wiring. Simply install the RTDs on or in the pipe as recommended, and then plug the RTDs into the UTM10.

Four ranges of surface mount RTDs and two lengths of wetted insertion probes are offered. Other cable lengths for surface mount RTDs are available. Contact the manufacturer for additional offerings.

All RTDs are 1000 Ohm platinum, three-wire devices. The surface mount versions are available in standard lengths of 6 m (20 ft), 15 m (50 ft) and 30 m (100 ft) of attached shielded cable.

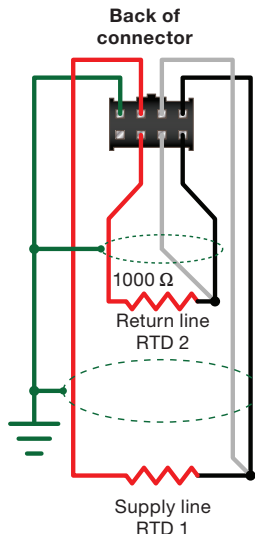

Fig. 34 RTD schematic

### 5.9.1 Installation of surface mount RTDs

Surface mount RTDs should only be utilized on well insulated pipe. If the area where the RTD is located is not insulated, inconsistent temperature readings will result. Insertion (wetted) RTDs should be used on pipes that are not insulated.

Select areas on the supply and return pipes where the RTDs will be mounted. Remove or peel back the insulation all the way around the pipe in the installation area. Clean an area slightly larger than the RTD down to bare metal on the pipe.

Place a small amount of heat sink compound on the pipe in the RTD installation location. See *Fig. 35*. Press the RTD firmly into the compound. Fasten the RTD to the pipe with the included stretch tape.

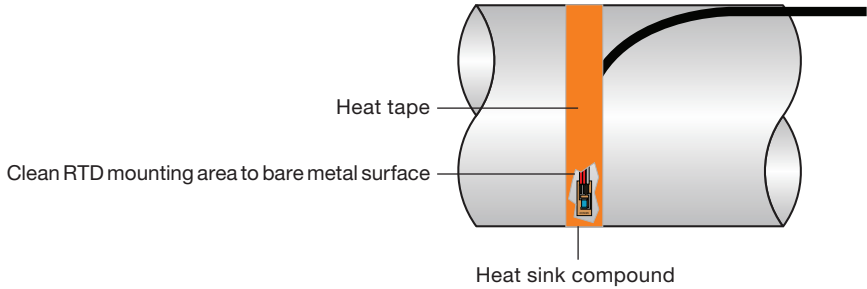

**Fig. 35 Surface mount RTD installation**

Route the RTD cables back to the UTM10 flow meter and secure the cable so that it will not be pulled on or abraded inadvertently. Replace the insulation on the pipe, ensuring that the RTDs are not exposed to air currents.

If the cables are not long enough to reach the UTM10, route the cables to an electrical junction box and add additional cable from that point. Use three-wire shielded cable, such as Belden® 9939 or equal, for this purpose.

**Note:** Adding cable adds to the resistance the flow meter reads and may have an effect on absolute accuracy. If cable is added, ensure that the same length is added to both RTDs to minimize errors due to changes in cable resistance.

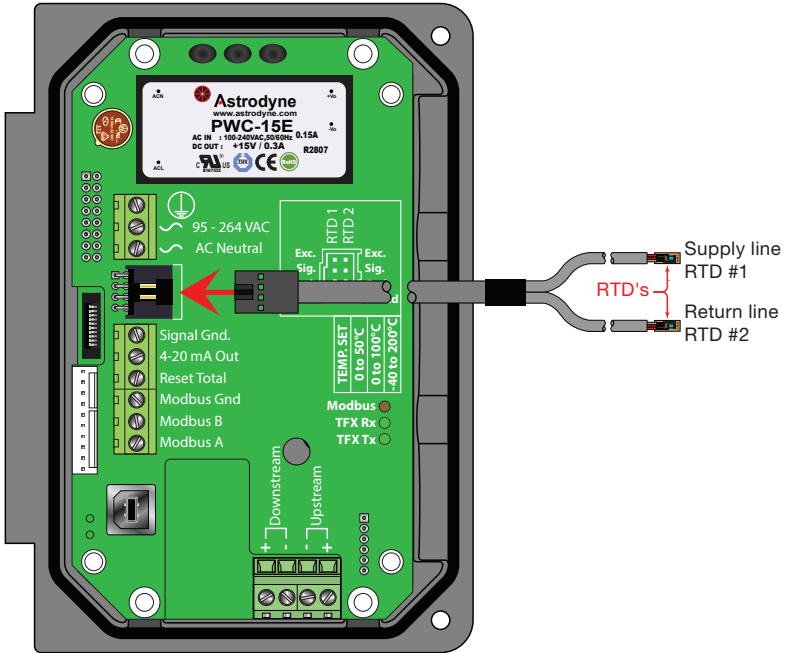

Fig. 36 Connecting RTDs

### 5.9.2 Wiring to the flow meter

After the RTDs have been mounted to the pipe, route the cable back to the UTM10 through the middle hole in the enclosure. Connection to the flow meter is accomplished by inserting the RTD connector into the mating connector on the circuit board. Be sure that the alignment tab on the RTD cable is up.

### 5.9.3 Replacement RTDs

If it is necessary to replace RTDs, complete RTD kits including the energy flow meters plug-in connector and calibration values for the replacements are available from the manufacturer.

It is also possible to use other manufacturer's RTDs. The RTDs must be 1000 Ohm platinum RTDs suitable for a three-wire connection. A connection adapter, P.N. D005-0350-300, is available to facilitate connection to the UTM10. See *Fig. 37*.

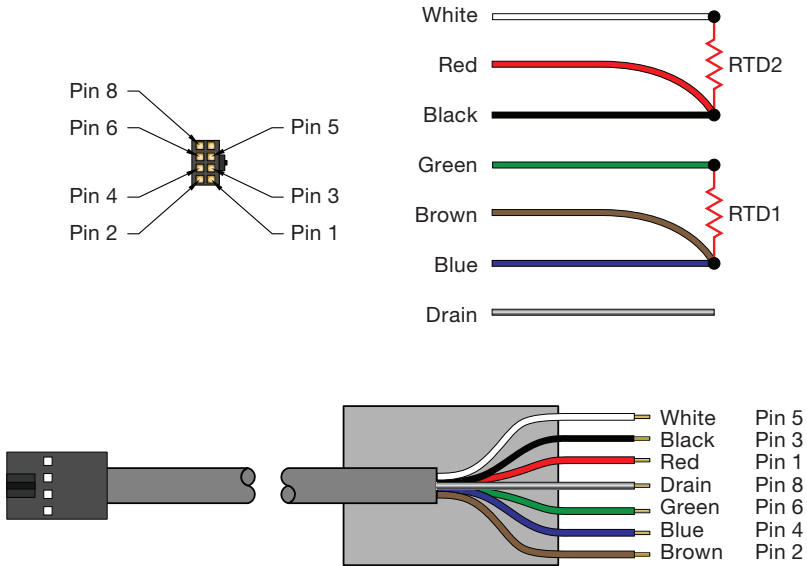

**Fig. 37 RTD adapter connections**

**Note:** It will be necessary to calibrate third party RTDs to the UTM10 for proper operation. See "Appendix" on page 88 for the calibration procedure.

## 6. Quick-start operating instructions

This section provides the basic instructions for operation. If specific instrument features are to be used or if the installer is unfamiliar with this type of instrument, refer to the appropriate Section in this document for complete details.



**Warning:** Before supplying power to the unit it is advised that Section 1 'Safety information' be read by the person commissioning the unit into operation.

**Please note:** It will be necessary to supply power to the unit, at least temporarily, to obtain set-up information that will be required in the following steps (6.1 to 6.4).

### 6.1 Transducer location

- 1) Select a mounting location on the piping system with a minimum of 10 pipe diameters ( $10 \times$  the pipe inside diameter) of straight pipe upstream and 5 straight diameters downstream. See "Table 1 Piping configuration and transducer positioning" on page 18.
- 2) If the application requires a UTT10-050S, UTT10-050L or UTT10-050H transducer, select a mounting method for the transducer based on pipe size and liquid characteristics. Transducer configurations are illustrated in Fig. 38.

**Note:** The UTT10-015S to UTT10-040S transducers use a V-mount configuration.

- 3) Enter the following data into the UTM10 transmitter via the integral keypad or the software utility:
  - Transducer mounting method
  - Pipe O.D. (Outside Diameter)
  - Pipe wall thickness
  - Pipe material
  - Pipe sound speed\*
  - Pipe relative roughness\*
  - Pipe liner thickness
  - Pipe liner material
  - Fluid type
  - Fluid sound speed\*
  - Fluid viscosity\*

\* Nominal values for these parameters are included within the UTM10 operating system. The nominal values may be used as they appear or may be modified if the exact system values are known.

- 4) Record the value calculated and displayed as Transducer Spacing (XDC SPAC).

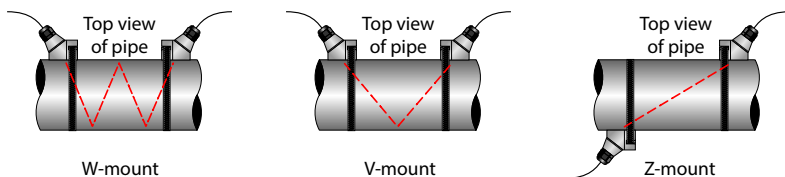

Fig. 38 Transducer mounting configurations

## 6.2 Electrical connections

### 6.2.1 Transducer / power connections

- 1) Route the transducer cables from the transducer mounting location back to the UTM10 enclosure. Connect the transducer wires to the terminal block in the UTM10 enclosure.
- 2) Verify that power supply is correct for the flow meters power option:
  - Line voltage ac units require 95 to 265 Vac 47 to 63 Hz @ 17 VA maximum.
  - Low voltage ac units require 20 to 28 Vac 47 to 63 Hz @ 17 VA maximum.
  - dc units require 10 to 28 Vdc @ 5 Watts maximum.
- 3) Connect the power to the UTM10 flow meter.

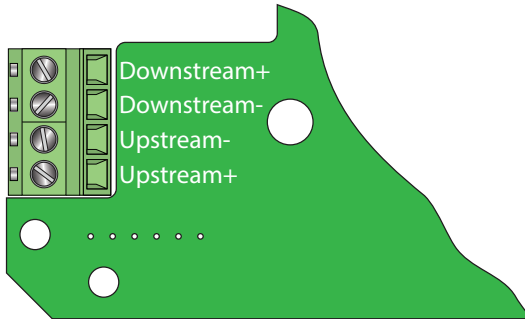

Fig. 39 Transducer connections

## 6.3 Pipe preparation and transducer mounting

### 6.3.1 UTT10-050S, UTT10-050L and UTT10-050H transducers

- 1) Place the flow meter in signal strength measuring mode. This value is available on the UTM10 display (Service Menu) or in the data display of the software utility.
- 2) The pipe surface, where the transducer is to be mounted, must be clean and dry. Remove any scale, rust or loose paint to ensure satisfactory acoustic conduction. Wire brushing the rough surface of the pipe to a smooth bare metal may also be useful. Plastic pipes do not require preparation other than cleaning.
- 3) Apply a single 12 mm (½") bead of acoustic couplant grease to the upstream transducer and secure it to the pipe with a mounting strap.
- 4) Apply acoustic couplant grease to the downstream transducer and press it onto the pipe using hand pressure at the lineal distance calculated in "*Transducer location*" on page 43.
- 5) Space the transducer according to the recommended values found during programming or from the software utility. Secure the transducer to the pipe with the mounting straps at these locations.



### **6.3.2 UTT10-015S to UTT10-040S transducers**

- 1) Place the flow meter in signal strength measuring mode. This value is available on the UTM10 display (Service Menu) or in the data display of the software utility.
- 2) The pipe surface, where the transducer is to be mounted, must be clean and dry. Remove any scale, rust or loose paint to ensure satisfactory acoustic conduction. Wire brushing the rough surface of the pipe to a smooth bare metal may also be useful. Plastic pipes do not require preparation other than cleaning.
- 3) Apply a single 12 mm (½") bead of acoustic couplant grease to the upstream transducer and secure it to the pipe with a mounting strap.
- 4) Tighten the nuts so that the acoustic coupling grease begins to flow out from the edges of the transducer and from the gap between the transducer and the pipe. Do not over tighten.

## **6.4 Start-up**

### **6.4.1 Initial settings and power up**

- 1) Apply power to the transmitter.
- 2) Verify that SIG STR is greater than 5.0.
- 3) Input proper units of measure and I/O data.

# 7. Start-up and Configuration

## 7.1 Before starting the instrument

**Note:** The UTM10 flow meter system requires a full pipe of liquid before a successful start-up can be completed. Do not attempt to make adjustments or change configurations until a full pipe is verified.

**Note:** If Dow 732 RTV was utilized to couple the transducers to the pipe, the adhesive must be fully cured before readings are attempted. Dow 732 requires 24 hours to cure satisfactorily. If Sonotemp® acoustic coupling grease was utilized as a couplant, curing is not required.

## 7.2 Instrument start-up procedure

- 1) Verify that all wiring is properly connected and routed, as described in "*Transmitter installation*" on page 12.
- 2) Verify that the transducer is properly mounted, as described in "*Transducer installation*" on page 17.
- 3) Apply power. The display of a UTM10 will briefly show a software version number and then all of the segments will illuminate in succession.

**Important:** In order to complete the installation of the UTM10 flow meter, the pipe must be full of liquid.

### To verify proper installation and flow measurement operation:

- 4) Go to the SER MENU and confirm that signal strength (SIG STR) is between 5 and 98. If the signal strength is lower than 5, verify that proper transducer mounting methods and liquid/pipe characteristics have been entered. To increase signal strength, if a W-mount transducer installation was selected, re-configure for a V-mount installation; if V-mount was selected, re-configure for Z-mount.

**Note:** Mounting configuration changes apply only to UTT10-050S, UTT10-050L and UTT10-050H transducer sets.

- 5) Verify that the actual measured liquid sound speed is very close to the expected value. The measured liquid sound speed (SSPD m/s (ft/s)) is displayed in the SER MENU. Verify that the measured sound speed is within 2% of the value entered as FLUID SS in the BSC MENU. The pipe must be full of liquid in order to make this measurement.

When the flow meter is operating properly, refer to "*Keypad programming*" on page 47 for additional programming features.

## 7.3 Keypad programming

The UTM10 units that have been ordered with a keypad can be configured through the keypad interface or by using the Windows® compatible software utility. See "*Software utility*" on page 70. Of the two methods of configuring the UTM10, the software utility provides more advanced features and offers the ability to store and transfer flow meter configurations between UTM10 units. All entries are saved in non-volatile FLASH memory and will be retained indefinitely in the event of power loss.

**Note:** When USB programming cable is connected, the RS485 and frequency outputs are disabled.

The UTM10 keypad contains a four-key tactile feedback keypad interface that allows the user to view and change configuration parameters used by the operating system.

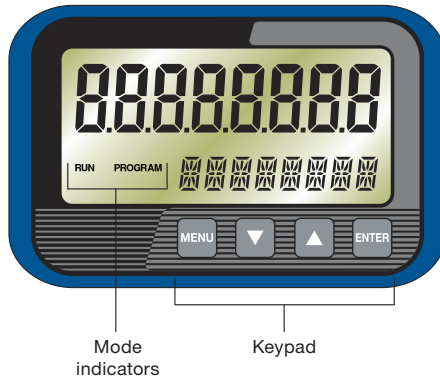

**Fig. 40 Keypad interface**

- 1) The MENU key is pressed from RUN mode to enter PROGRAM mode. The MENU key is pressed in PROGRAM mode to exit from configuration parameter selection and menus. If changes to any configuration parameters are made, the user will be prompted with a SAVE? when returning to RUN mode. If YES is chosen the new parameters will be saved in program memory.
- 2) The arrow ▲▼ keys are used to scroll through menus and configuration parameters. The arrow keys are also used to adjust parameter numerical values.
- 3) The ENTER key functions are:
  - Pressed from the RUN mode to view the current software version operating in the instrument.
  - Used to access the configuration parameters in the various menus.
  - Used to initiate changes in configuration parameters.
  - Used to accept configuration parameter changes.

## 7.4 Menu structure

The UTM10 firmware uses a hierarchical menu structure. A map of the user interface is included in "Appendix" on page 88. The map provides a visual path to the configuration parameters that users can access. This tool should be employed each time configuration parameters are accessed or revised.

The seven menus used in the UTM10 software are as follows:

<b>BSC MENU</b>	BASIC - This menu contains all of the configuration parameters necessary to initially program the UTM10 to measure flow.	"BSC menu - Basic menu" on page 48
<b>CH1 MENU</b>	CHANNEL 1 - Configures the 4-20 mA output. Applies to both the UTM10-S and UTM10-E (energy) models.	"CH1 menu - Channel 1 menu" on page 58
<b>CH2 MENU</b>	CHANNEL 2 - Configures the type and operating parameters for channel 2 output options. Channel 2 parameters are specific to the model of UTM10 used.	"CH2 menu - Channel 2 menu" on page 60
<b>SEN MENU</b>	SENSOR - This menu is used to select the sensor type (i.e. STD 1 MHZ, etc.)	"SEN menu - Sensor menu" on page 62
<b>SEC MENU</b>	SECURITY - This menu is utilized for resetting totalizers, returning filtering to factory settings, and revising security the password.	"SEC menu - Security menu" on page 63
<b>SER MENU</b>	SERVICE - The service menu contains system settings that are used for advanced configuration and zeroing the UTM10 on the pipe.	"SER menu - Service menu" on page 63
<b>DSP MENU</b>	DISPLAY - The display menu is used to configure the UTM10 display functions.	"DSP menu - Display menu" on page 68

The following sections define the configuration parameters located in each of the menus.

## 7.5 BSC menu - Basic menu

The BASIC menu contains all of the configuration parameters necessary to make the UTM10 operational.

### Units selection:

**UNITS - Programming unit selection (choice)**

**METRIC (Millimetres)**

**IMPERIAL (Inches)**

Installs a global measurement standard into the memory of the instrument. The choices are either Metric or Imperial units.

Select METRIC if the flow meter is to be configured in millimetres. Select IMPERIAL if all configurations (pipe sizes, etc.) are to be made in inches.

The METRIC / IMPERIAL selection will also configure the UTM10 to display sound speeds in pipe materials and liquids as either metres/second (MPS) or feet/second (FPS), respectively.

**Important!** If the UNITS entered have been changed from METRIC to IMPERIAL or vice versa the entry must be saved and the instrument reset (power cycled or System Reset SYS RSET entered) in order for the UTM10 to initiate the change in operating units. Failure to save and reset the instrument will lead to improper transducer spacing calculations and an instrument that may not measure properly.

## Address

**ADDRESS - Modbus address (Value)**  
1-126

**Note:** This is for the RS485 connection only. The Modbus TCP/IP address is set via the integrated HTML application in the Ethernet port.

Each UTM10 connected on the communications bus must have a unique address number assigned.

## BAUD

**Baud rate of RS485 (Value)**  
9600  
14400  
19200  
38400  
56000  
57600  
76800

## BACnet ID

**BACnet ID (Value)**  
0 - 4194303

**Note:** This is for the BACnet networks only.

## Transducer mount

**XDCR MNT - Transducer mounting method (Choice)**

V

W

Z

Selects the mounting orientation for the transducers. The selection of an appropriate mounting orientation is based on pipe and liquid characteristics. See "*Transducer installation*" on page 17.

## Flow direction

**FLOW DIR - Transducer flow direction control (Choice)**

FORWARD

REVERSE

Allows the flow direction to be changed from that which the flow meter assumes to be forward. This feature allows upstream and downstream transducers to be 'electronically' reversed making upside down mounting of the display unnecessary when mounting a UTM10 flow meter with integral transducer.

## Transducer frequency

**XDCR HZ - Transducer transmission frequency (Choice)**

**500 KHZ (500 Kilohertz)**

**1 MHZ (1 Megahertz)**

**2 MHZ (2 Megahertz)**

Transducer transmission frequencies are specific to the type of transducer and the size of pipe. In general the UTT10-050L 500 KHz transducers are used for pipes greater than 600 mm (24"). UTT10-050S and UTT10-050H, 1 MHz transducers, are for intermediate sized pipes between 50 mm (2") and 600 mm (24"). The UTT10-015S to UTT10-040S, 2 MHz transducers, are for pipe sizes between 15 mm (½") and 40 mm (1½").

## Pipe outside diameter

**PIPE OD - Pipe outside diameter entry (Value)**

**METRIC (Millimetres)**

**IMPERIAL (Inches)**

Enter the pipe outside diameter in millimetres if METRIC was selected as your choice of units.

**Note:** Charts listing popular pipe sizes have been included in "*Appendix*" on page 88. Correct entries for pipe O.D. and pipe wall thickness are critical to obtaining accurate flow measurement readings.

## Pipe wall thickness

**PIPE WT - Pipe wall thickness entry (Value)**

**METRIC (Millimetres)**

**IMPERIAL (Inches)**

Enter the pipe wall thickness in millimetres if METRIC was selected as your choice of units.

**Note:** Charts listing popular pipe sizes have been included in "*Appendix*" on page 88. Correct entries for pipe O.D. and pipe wall thickness are critical to obtaining accurate flow measurement readings.

## Pipe material

### PIPE MAT - Pipe material selection (Choice)

The following list is provided as an example. Additional pipe materials are added periodically. Select the appropriate pipe material from the list or select OTHER if the material is not listed.

<b>Acrylic</b>	(ACRYLIC)
<b>Aluminum</b>	(ALUMINUM)
<b>Brass (Naval)</b>	(BRASS)
<b>Carbon steel</b>	(CARB ST)
<b>Cast iron</b>	(CAST IRN)
<b>Copper</b>	(COPPER)
<b>Ductile iron</b>	(DCTL IRN)
<b>Fiberglass-Epoxy</b>	(FBRGLASS)
<b>Glass Pyrex</b>	(PYREX)
<b>Nylon</b>	(NYLON)
<b>HD Polyethylene</b>	(HDPE)
<b>LD Polyethylene</b>	(LDPE)

<b>Polypropylene</b>	(POLYPRO)
<b>PVC CPVC</b>	(PVC/CPVC)
<b>PVDF</b>	(PVDF)
<b>Stainless steel 302/303</b>	(SS 303)
<b>Stainless steel 304/316</b>	(SS 316)
<b>Stainless steel 410</b>	(SS 410)
<b>Stainless steel 430</b>	(SS 430)
<b>PFA</b>	(PFA)
<b>Titanium</b>	(TITANIUM)
<b>Asbestos</b>	(ASBESTOS)
<b>Other</b>	(OTHER)

## Pipe sound speed

### PIPE SS - Speed of sound in the pipe material (Value)

#### METRIC (metres per second)

#### IMPERIAL (feet per second)

Allows adjustments to be made to the speed of sound value, shear or transverse wave, for the pipe wall. If METRIC was chosen as your choice of units, the entry will be in MPS (metres/second). If IMPERIAL was chosen, the entry will be in FPS (feet/second).

If a pipe material was chosen from the PIPE MAT list, a nominal value for speed of sound in that material will be automatically loaded. If the actual sound speed is known for the application piping system and that value varies from the automatically loaded value, the value can be revised.

If OTHER was chosen as PIPE MAT, then a PIPE SS must also be entered.

## Pipe roughness

### PIPE R - Pipe material relative roughness (Value)

#### Unitless value

The UTM10 provides flow profile compensation in its flow measurement calculation. The ratio of average surface imperfection as it relates to the pipe internal diameter is used in this compensation algorithm and is found by using the following formula:

$$\text{Pipe R} = \frac{\text{Linear RMS measurement of the pipe internal wall surface}}{\text{Inside diameter of the pipe}}$$

If a pipe material was chosen from the PIPE MAT list, a nominal value for relative roughness in that material will be automatically loaded. If the actual roughness is known for the application piping system and that value varies from the automatically loaded value, the value can be revised.

## Liner thickness

### LINER T - Pipe liner thickness (Value)

#### METRIC (Millimetres)

#### IMPERIAL (Inches)

If the pipe has a liner, enter the pipe liner thickness. If METRIC was chosen as your choice of units, enter this value in millimetres. If IMPERIAL was chosen, enter this value in inches.

## Liner material

### LINER MA - Pipe liner material (Choice)

#### Liner type - (If a LINER thickness was selected)

The following list is provided as an example. Additional materials are added periodically. Select the appropriate material from the list or select OTHER if the liner material is not listed.

Tar Epoxy	(TAR EPXY)
Rubber	(RUBBER)
Mortar	(MORTAR)
Polypropylene	(POLYPRO)
Polystyrene	(POLYSTY)

<b>HD Polyethylene</b>	(HDPE)
<b>LD Polyethylene</b>	(LDPE)
<b>Teflon (PFA)</b>	(TEFLON)
<b>Ebonite</b>	(EBONITE)
<b>Other</b>	(OTHER)

## Liner sound speed

### LINER SS - Speed of Sound in the Liner (Value)

#### METRIC (metres per second)

#### IMPERIAL (feet per second)

Allows adjustments to be made to the speed of sound value, shear or transverse wave, for the pipe wall. If METRIC was chosen as your choice of units, the entry will be in MPS (metres/second). If IMPERIAL was chosen, the entry will be in FPS (feet/second).

If a liner was chosen from the LINER MA list, a nominal value for speed of sound in that media will be automatically loaded. If the actual sound speed rate is known for the pipe liner and that value varies from the automatically loaded value, the value can be revised.

## Liner roughness

### LINER R - Liner material relative roughness (Value)

#### Unitless value

The UTM10 provides flow profile compensation in its flow measurement calculation. The ratio of average surface imperfection as it relates to the pipe internal diameter is used in this compensation and is found by using the following formula:

$$\text{Liner R} = \frac{\text{Linear RMS measurement of the pipe internal wall surface}}{\text{Inside diameter of the pipe}}$$

If a liner material was chosen from the LINER MA list, a nominal value for relative roughness in that material will be automatically loaded. If the actual roughness is known for the application liner and that value varies from the automatically loaded value, the value can be revised.



## Fluid type

### FL TYPE - Fluid/media type (Choice)

The following list is provided as an example. Additional liquids are added periodically. Select the appropriate liquid from the list or select OTHER if the liquid is not listed.

<b>Water Tap</b>	(WATER)
<b>Sewage-Raw</b>	(SEWAGE)
<b>Acetone</b>	(ACETONE)
<b>Alcohol</b>	(ALCOHOL)
<b>Ammonia</b>	(AMMONIA)
<b>Benzene</b>	(BENZENE)
<b>Brine</b>	(BRINE)
<b>Ethanol</b>	(ETHANOL)
<b>Ethylene Glycol</b>	(ETH-GLYC)
<b>Gasoline</b>	(GASOLINE)
<b>Glycerin</b>	(GLYCERIN)

<b>Isopropyl Alcohol</b>	(ISO-ALC)
<b>Kerosene</b>	(KEROSENE)
<b>Methanol</b>	(METHANOL)
<b>Oil Diesel</b>	(DIESEL)
<b>Oil Hydraulic [Petro-based]</b>	(HYD OIL)
<b>Oil Lubricating</b>	(LUBE OIL)
<b>Oil Motor [SAE 20/30]</b>	(MTR OIL)
<b>Water Distilled</b>	(WATR-DST)
<b>Water Sea</b>	(WATR-SEA)
<b>Other</b>	(OTHER)

## Fluid sound speed

### FLUID SS - Speed of sound in the fluid (Value)

#### METRIC (metres per second)

#### IMPERIAL (feet per second)

Allows adjustments to be made to the speed of sound entry for the liquid. If METRIC was chosen as your choice of units, the entry will be in MPS (metres/second). If IMPERIAL was chosen, the entry will be in FPS (feet/second).

If a fluid was chosen from the FL TYPE list, a nominal value for speed of sound in that media will be automatically loaded. If the actual sound speed is known for the application fluid and that value varies from the automatically loaded value, the value can be revised.

If OTHER was chosen as FL TYPE, a FLUID SS will need to be entered. A list of alternate fluids and their associated sound speeds is located in "*Table 23 - Fluid properties*" on page 116.

Fluid sound speed may also be found using the Target DBg Data screen available in "*Software utility*" on page 70.

## Fluid viscosity

### FLUID VI - Absolute viscosity of the fluid (Value - cP)

Allows adjustments to be made to the absolute viscosity of the liquid in centipoise.

UTM10 flow meters utilize pipe size, viscosity and specific gravity to calculate Reynolds numbers. Since the Reynolds number influences flow profile, the UTM10 has to compensate for the relatively high velocities at the pipe center during transitional or laminar flow conditions. The entry of FLUID VI is utilized in the calculation of Reynolds and the resultant compensation values.

If a fluid was chosen from the FL TYPE list, a nominal value for viscosity in that media will be automatically loaded. If the actual viscosity is known for the application fluid and that value varies from the automatically loaded value, the value can be revised.

If OTHER was chosen as FL TYPE, then a FLUID VI must also be entered. A list of alternate fluids and their associated viscosities is located in "*Table 23 - Fluid properties*" on page 116.

## Fluid specific gravity

### SP GRAVITY - Fluid specific gravity entry (Value) Unitless Value

Allows adjustments to be made to the specific gravity (density relative to water) of the liquid.

As stated previously in the FLUID VI section, specific gravity is utilized in the Reynolds correction algorithm. It is also utilized if mass flow measurement units are selected for rate or total.

If a fluid was chosen from the FL TYPE list, a nominal value for specific gravity in that media will be automatically loaded. If the actual specific gravity is known for the application fluid and that value varies from the automatically loaded value, the value can be revised.

If OTHER was chosen as FL TYPE, a SP GRVITY may need to be entered if mass flows are to be calculated. A list of alternate fluids and their associated specific gravities is located in "Table 23 - Fluid properties" on page 116.

## Fluid specific heat capacity

### SP HEAT - Fluid specific heat capacity (Value) BTU/lb

Allows adjustments to be made to the specific heat capacity of the liquid.

If a fluid was chosen from the FL TYPE list, a default specific heat will be automatically loaded. This default value is displayed as SP HEAT in the BSC MENU. If the actual specific heat of the liquid is known or it differs from the default value, the value can be revised. See Table 6, Table 7 and Table 8 on page 55 for specific values. Enter a value that is the mean of both pipes.

**Table 6 Specific heat capacity values for water**

Specific heat capacity for water			Specific Heat BTU/lb°F
Temperature			
°C		°F	
0-100		32-212	1.00
121		250	1.02
149		300	1.03
177		350	1.05

**Table 7 Specific heat capacity values for other common fluids**

Specific heat capacity values for common fluids			
Fluid	Temperature		Specific heat BTU/lb°F
	°C	°F	
Ethanol	0	32	0.65
Methanol	12	54	0.60
Brine	0	32	0.71
Brine	15	60	0.72
Sea water	17	63	0.94

**Table 8 Specific heat capacity values for ethylene glycol/water**

Temperature		Specific heat capacity BTU/lb°F						
		Ethylene Glycol solution (% by Volume)						
°C	°F	25	30	40	50	60	65	100
-40	-40	n/a	n/a	n/a	n/a	0.68	0.70	n/a
-17.8	0	n/a	n/a	0.83	0.78	0.72	0.70	0.54
4.4	40	0.91	0.89	0.84	0.80	0.75	0.72	0.56
26.7	80	0.92	0.90	0.86	0.82	0.77	0.74	0.59
84.9	120	0.93	0.92	0.88	0.83	0.79	0.77	0.61
71.1	160	0.94	0.93	0.89	0.85	0.81	0.79	0.64
93.3	200	0.95	0.94	0.91	0.87	0.83	0.81	0.66
115.6	240	n/a	n/a	n/a	n/a	n/a	0.83	0.69

**Transducer spacing**

**XDC SPAC - Transducer Spacing Calculation (Value)**

**METRIC (Millimetres)**

**IMPERIAL (Inches)**

**Note:** This value is calculated by the firmware after all pipe parameters have been entered. The spacing value only pertains to UTT10-050S, UTT10-050L and UTT10-050H transducer sets.

This value represents the one-dimensional linear measurement between the transducers (the upstream / downstream measurement that runs parallel to the pipe). If METRIC was chosen as your choice of units, the entry will be in millimetres. If IMPERIAL was chosen, the entry will be in inches. This measurement is taken between the lines which are scribed into the side of the transducer blocks.

If the transducers are being mounted using the transducer track assembly, a measuring scale is etched into the track. Place one transducer at 0 and the other at the appropriate measurement.

**Rate units**

**RATE UNT - Engineering units for flowrate (Choice)**

Select a desired engineering unit for flowrate measurements.

<b>Gallons</b>	(Gallons)	<b>Pounds</b>	(LB)
<b>Litres</b>	(Litres)	<b>Kilograms</b>	(KG)
<b>Millions of Gallons</b>	(MGal)	<b>British Thermal Units</b>	(BTU)
<b>Cubic Feet</b>	(Cubic Ft)	<b>Thousands of BTUs</b>	(MBTU)
<b>Cubic Metres</b>	(Cubic Me)	<b>Millions of BTUs</b>	(MMBTU)
<b>Acre Feet</b>	(Acre Ft)	<b>Ton Hours</b>	(TON)
<b>Oil Barrels</b>	(Oil Barr)[42 Gallons]	<b>Kilojoule</b>	(KJ)
<b>Liquor Barrels</b>	(Liq Barr) [31.5 Gallons]	<b>Kilowatt Hours</b>	(KWH)
<b>Feet</b>	(Feet)	<b>Megawatt Hours</b>	(MWH)
<b>Metres</b>	(Metres)		

**Rate interval**

**RATE INT - Time interval for flowrate (Choice)**

**SEC**      **Seconds**

**MIN**      **Minutes**

**HOUR**    **Hours**

**DAY**      **Days**

Select a desired engineering unit for flowrate measurements.

## Totalizer units

### TOTL UNT - Totalizer units

Select a desired engineering unit for flow accumulator (totalizer) measurements.

<b>Gallons</b>	(Gallons)	<b>Pounds</b>	(LB)
<b>Litres</b>	(Litres)	<b>Kilograms</b>	(KG)
<b>Millions of Gallons</b>	(MGal)	<b>British Thermal Units</b>	(BTU)
<b>Cubic Feet</b>	(Cubic Ft)	<b>Thousands of BTUs</b>	(MBTU)
<b>Cubic Metres</b>	(Cubic Me)	<b>Millions of BTUs</b>	(MMBTU)
<b>Acre Feet</b>	(Acre Ft)	<b>Ton Hours</b>	(TON)
<b>Oil Barrels</b>	(Oil Barr)[42 Gallons]	<b>Kilojoule</b>	(KJ)
<b>Liquor Barrels</b>	(Liq Barr) [31.5 Gallons]	<b>Kilowatt Hours</b>	(KWH)
<b>Feet</b>	(Feet)	<b>Megawatt Hours</b>	(MWH)
<b>Metres</b>	(Metres)		

## Totalizer exponent

### TOTL E - Flow totalizer exponent value (Choice)

#### E(-1) to E6

Utilized for setting the flow totalizer exponent. This feature is useful for accommodating a very large accumulated flow or to increase totalizer resolution when flows are small (displaying fractions of whole barrels, gallons, etc.) The exponent is a  $\times 10^n$  multiplier, where 'n' can be from  $-1 (\times 0.1)$  to  $+6 (\times 1,000,000)$ . Table 8 should be referenced for valid entries and their influence on the display. Selection of E-1 and E0 adjusts the decimal point on the display. Selection of E1, E2 and E3 causes an icon of  $\times 10$ ,  $\times 100$  or  $\times 1000$  respectively to appear to the right of the total flow display value.

**Table 9 Exponent values**

<b>Exponent</b>	<b>Display multiplier</b>
<b>E-1</b>	$\times 0.1$ ( $\div 10$ )
<b>E0</b>	$\times 1$ (no multiplier)
<b>E1</b>	$\times 10$
<b>E2</b>	$\times 100$
<b>E3</b>	$\times 1,000$
<b>E4</b>	$\times 10,000$
<b>E5</b>	$\times 100,000$
<b>E6</b>	$\times 1,000,000$

## Minimum flowrate

### **MIN RATE - Minimum flowrate settings (Value)**

A minimum rate setting is entered to establish filter software settings and the lowest rate value that will be displayed. Volumetric entries will be in the Rate Units and Interval selected on Page 49 of this manual. For unidirectional measurements, set MIN RATE to zero. For bidirectional measurements, set MIN RATE to the highest negative (reverse) flowrate expected in the piping system.

**Note:** The flow meter will not display a flowrate at flows less than the MIN RATE value. As a result, if the MIN RATE is set to a value greater than zero, the flow meter will display the MIN RATE value, even if the actual flow/energy rate is less than the MIN RATE.

For example, if the MIN RATE is set to 25 and actual rate is 0, the flow meter display will indicate 25. Another example, if the MIN RATE is set to -100 and the actual flow is -200, the flow meter will indicate -100. This can be a problem if the flow meter MIN RATE is set to a value greater than zero because at flows below the MIN RATE the rate display will show zero flow, but the totalizer which is not affected by the MIN RATE setting will keep totalizing.

## Maximum flowrate

### **MAX RATE - Maximum flowrate settings (Value)**

A maximum volumetric flowrate setting is entered to establish filter software settings. Volumetric entries will be in the Rate Units and Interval selected on Page 49. For unidirectional measurements, set MAX RATE to the highest (positive) flowrate expected in the piping system. For bidirectional measurements, set MAX RATE to the highest (positive) flowrate expected in the piping system.

## Low flow cut-off

### **FL C-OFF - Low flow cut-off (Value)** **0-100%**

A low flow cut-off entry is provided to allow very low flowrates (that can be present when pumps are off and valves are closed) to be displayed as zero flow. Typical values that should be entered are between 1.0% and 5.0% of the flow range between MIN RATE and MAX RATE.

## Damping percentage

### **DAMP PER - System damping (Value)** **0-100%**

Flow filter damping establishes a maximum adaptive filter value. Under stable flow conditions (flow varies less than 10% of reading), this adaptive filter will increase the number of successive flow readings that are averaged together up to this maximum value. If flow changes outside of the 10% window, the flow filter adapts by decreasing the number of averaged readings which allows the flow meter to react faster. Increasing this value tends to provide smoother steady-state flow readings and outputs. If very erratic flow conditions are present or expected, other filters are available for use in the software utility. See "*Software utility*" on page 70.

## 7.6 CH1 menu - Channel 1 menu

### CH1 MENU - 4-20 mA output menu (Applies to all UTM10 Versions)

**4-20 MA - 4-20 mA set-up options (Values)**

**FL 4MA** Flow at 4 mA

**FL 20MA** Flow at 20 mA

**CAL 4MA** 4 mA calibration

**CAL 20MA** 20 mA calibration

**4-20 TST** 4-20 mA test

The CH1 menu controls how the 4-20 mA output is spanned for all the UTM10 flow meters and how the frequency output is spanned for the UTM10-S flow model.

The FL 4MA and FL 20MA settings are used to set the span for both the 4-20 mA output and the 0 - 1000 Hz frequency output on the UTM10-S flow meter versions.

The 4-20 mA output is internally powered (current sourcing) and can span negative to positive flow / energy rates. This output interfaces with virtually all recording and logging systems by transmitting an analog current that is proportional to system flowrate. Independent 4 mA and 20 mA span settings are established in firmware using the flow measuring range entries. These entries can be set anywhere in the -12 to +12 metres/second (-40 to + 40 feet/second) range of the instrument. Resolution of the output is 12-bits (4096 discrete points) and the can drive up to a 400 Ohm load when the flow meter is ac powered. When powered by a dc supply, the load is limited by the input voltage supplied to the instrument. See *Fig. 24 on page 32* for allowable loop loads.

**FL 4MA - Flow at 4 mA**

**FL 20MA - Flow at 20 mA**

The FL 4MA and FL 20MA entries are used to set the span of the 4-20 mA analog output and the frequency output on UTM10-S flow meter versions. These entries are volumetric rate units that are equal to the volumetric units configured as RATE UNT and RATE INT discussed on *page 55*.

**Example 1** - To span the 4-20 mA output from -100 to +100 litres/minute (LPM), with 12 mA being 0 litres/minute, set the FL 4MA and FL 20MA inputs as follows:

**FL 4MA = -100.0**

**FL 20MA = 100.0**

If the flow meter were a UTM10-S, this setting would also set the span for the frequency output. At -100 litres/minute (LPM), the output frequency would be 0 Hz. At the maximum flow of 100 litres/minute, the output frequency would be 1000 Hz, and in this instance a flow of zero would be represented by an output frequency of 500 Hz.

**Example 2** - To span the 4-20 mA output from 0 to 100 litres/minute (LPM), with 12 mA being 50 litres/minute, set the FL 4MA and FL 20MA inputs as follows:

**FL 4MA = 0.0**

**FL 20MA = 100.0**

For the UTM10-S flow meter, in this instance zero flow would be represented by 0 Hz and 4 mA. The full-scale flow or 100 litres/minute (LPM) would be 1000 Hz and 20 mA, and a midrange flow of 50 litres/minute would be expressed as 500 Hz and 12 mA.

The 4-20 mA output is factory calibrated and should not require adjustment. If small adjustments to the DAC (Digital to Analog Converter) are needed, for instance if adjustment due to the accumulation of line losses from long output cable lengths are required, the CAL 4 mA and CAL 20 MA can be used.

**CAL 4 MA - 4 mA DAC calibration entry (Value)**

**CAL 20 MA- 20 mA DAC calibration entry (Value)**

The CAL 4MA and CAL 20 MA entries allow fine adjustments to be made to the 'zero' and full-scale of the 4-20 mA output. To adjust the outputs, an ammeter or reliable reference connection to the 4-20 mA output must be present.

**Note:** Calibration of the 20 mA setting is conducted much the same way as the 4 mA adjustments.

**Note:** The CAL 4MA and CAL 20MA entries should not be used in an attempt to set the 4-20 mA range. Utilize FL 4MA and FL 20MA, detailed above, for this purpose.

#### **4 mA calibration procedure:**

- 1) Disconnect one side of the current loop and connect the ammeter in series (disconnect either wire at the terminals labeled 4-20 mA Out or Signal Gnd).
- 2) Using the arrow keys, increase the numerical value to increase the current in the loop to 4 mA. Decrease the value to decrease the current in the loop to 4 mA. Typical values range between 40-80 counts.
- 3) Reconnect the 4-20 mA output circuitry as required.

#### **20 mA calibration procedure:**

- 1) Disconnect one side of the current loop and connect the ammeter in series (disconnect either wire at the terminals labeled 4-20 mA Out or Signal Gnd).
- 2) Using the arrow keys, increase the numerical value to increase the current in the loop to 20 mA. Decrease the value to decrease the current in the loop to 20 mA. Typical values range between 3700-3900 counts.
- 3) Reconnect the 4-20 mA output circuitry as required.

### **4-20 TST - 4-20 mA output test (Value)**

Allows a simulated flow value to be sent from the 4-20 mA output. By incrementing this value, the 4-20 mA output will transmit the indicated current value.

## 7.7 CH2 menu - Channel 2 menu

The CH2 menu is used to configure model specific I/O options. The UTM10-S flow meter presents a different set of parameters than the UTM10-E flow meter.



**Caution:** It is possible to choose options pertaining only to the UTM10-S flow meter when a UTM10-E flow meter is present. The opposite is also true. The proper menu type must be chosen for the actual flow meter. If this caution isn't followed, the outputs or flow meter readings will be unpredictable.

### Channel 2 options

**CH2 Menu - Channel 2 I/O options (Choice)**

**RTD - Input values for UTM10-E flowmeters (Values)**

**CONTROL/HZ - Output options for UTM10-S flow meters**

### UTM10-E options

**RTD - Calibration values (Value)**

**RTD1 A Calibration value for RTD1 A**

**RTD1 B Calibration value for RTD1 B**

**RTD2 A Calibration value for RTD2 A**

**RTD2 B Calibration value for RTD2 B**

Inputs from two 1 000 Ohm platinum RTD temperature sensors allow measurements of heating or cooling usage.

The values used to calibrate the RTD temperature sensors are derived in the laboratory and are specific to the RTD and to the electronic circuit it is connected to. The RTDs on new units come with the calibration values already entered into the UTM10 and should not need to be changed.

Field replacement of RTDs is possible through the use of the keypad or the software utility. If the RTDs were ordered from the manufacturer, they will come with calibration values that need to be loaded into the UTM10.

New, non-calibrated RTDs will need to be field calibrated using an ice bath and boiling water to derive calibration values. This procedure is outlined in *"In field calibration of RTD temperature sensors" on page 100.*

**Table 10 RTDs**

Surface mount RTDs		
<b>URTD-C-20</b>	Set of two:	Maximum temperature 200°C (392°F) Cable length 6 m (20 ft)
<b>URTD-C-50</b>	Set of two:	Maximum temperature 200°C (392°F) Cable length 15 m (50 ft)
<b>URTD-C-100</b>	Set of two:	Maximum temperature 200°C (392°F) Cable length 30 m (100 ft)

### UTM10-S options

Two independent open collector transistor outputs are included with the UTM10-S model. Each output can be configured independently for one of the following:



## CONTROL/HZ - Control options (Choice)

Select either Control 1 or Control 2 to program.

### TOTALIZE - Totalizer output options

#### TOT MULT -Totalizer multiplier (Value)

Sets the multiplier value applied to the totalizing pulse output.

### FLOW - Flow alarm output options

#### FLOW - Flow alarm values

##### ON (Value)

Sets value at which the alarm output will turn ON.

##### OFF (Value)

Sets value at which the alarm output will turn OFF.

### SIG STR - Signal strength alarm options

#### SIG STR - Signal strength alarm values

##### ON (Value)

Sets value at which the alarm output will turn ON.

##### OFF (Value)

Sets value at which the alarm output will turn OFF.

## ERRORS

Alarm outputs on any error condition. See Error Table in the "*Appendix*" on page 88.

## NONE

Alarm outputs disabled.

**Note:** The set-up options for both CONTROL 1 and CONTROL 2 follow the same menu path. For a complete view of the menu options, see "*Menu Maps*" on page 92.

## 7.8 SEN menu - Sensor menu

The SEN MENU allows access to the various types of transducers the UTM10 can work with. Selecting the proper transducers in conjunction with the transducer mount (XDCR MNT) and transducer frequency (XDCR HZ) is critical to accurate operation of the flow meter.

### SEN MENU - Transducer selection menu (Choice)

#### **050SX (UTT10-050S)**

Used on pipes 51 mm (2") and larger.

#### **050HX (UTT10-050H)**

High temperature version of UTT10-050S.

#### **050LX (UTT10-050L)**

Used on pipes 600 mm (24") and larger.

For pipes 600 mm (24") and larger the UTT10-050L transducers using a transmission frequency of 500 KHz are recommended.

UTT10-050L transducers may also be advantageous on pipes between 100 mm - 600 mm (4" - 24") if there are less quantifiable complicating aspects such as, sludge, tuberculation, scale, rubber liners, plastic liners, thick mortar, gas bubbles, suspended solids, emulsions, or pipes that are perhaps partially buried where a V-mount is required / desired, etc.

#### **0NNSC (Copper Pipe)**

Used with UTT10-015S to UTT10-040S small pipe transducers.

UTT10-015S to UTT10-040S

#### **0NNSP (ASME Pipe)**

Used with UTT10-015S to UTT10-040S small pipe transducers.

UTT10-015S to UTT10-040S

#### **0NNSM (Tubing)**

Used with UTT10-015S to UTT10-040S small pipe transducers.

UTT10-015S to UTT10-040S

## 7.9 SEC menu - Security menu

The SEC MENU menu allows access to flow meter functions that may need to be protected from changes.

### SEC MENU - Security function selection menu

#### **TOT RES - Totalizer reset (Choice)**

**YES**

**NO**

Resets the totalizing displayed on the LCD to zero.

#### **SYS RES - System reset (Choice)**

**YES**

**NO**

Restarts the flow meter's microprocessor. This is similar to power cycling the flow meter.

#### **CH PSWD? - Change password (Value)**

0 - 9999

The password comes from the factory set to 0000. When set to 0000 the password function is disabled. By changing the password from 0000 to some other value (any value between 0001-9999), configuration parameters will not be accessible without first entering the password value when prompted. If the value is left at 0000, no security is invoked and unauthorized changes can be made. Access to resetting of the totalizer is also protected by this password. If the password is lost or forgotten, contact the manufacturer for a universal password to unlock the flow meter.

## 7.10 SER menu - Service menu

The SER MENU menu allows access to flow meter set-up values that may need revision due to application specific conditions and information valuable in troubleshooting.

### SER MENU - Service menu

#### **SSPD MPS - Liquid sound speed (metres per second) (Reported by Firmware)**

#### **SSPD FPS - Liquid sound speed (feet per second) (Reported by Firmware)**

The UTM10 performs an actual speed of sound calculation for the liquid it is measuring. This speed of sound calculation will vary with temperature, pressure and fluid composition.

The UTM10 will compensate for fluid sound speeds that vary within a window of  $\pm 10\%$  of the liquid specified in the BSC MENU. If this range is exceeded, error code 0011 will appear on the display and the sound speed entry must be corrected.

The value indicated in SSPD measurement should be within 10% of the value entered/indicated in the BSC MENU item FLUID SS. (The SSPD value itself cannot be edited.) If the actual measured value is significantly different ( $> \pm 10\%$ ) than the BSC MENU's FLUID SS value, it typically indicates a problem with the instrument set-up. An entry such as FL TYPE, PIPE OD or PIPE WT may be in error, the pipe may not be round or the transducer spacing is not correct.

Table 10 lists sound speed values for water at varying temperatures. If the UTM10 is measuring sound speed within 2% of the table values, then the installation and setup of the instrument is correct.

**Table 11 Sound speed of water**

Temperature		Velocity	
°C	°F	MPS	FPS
0	32	1402	4600
10	50	1447	4747
20	68	1482	4862
30	86	1509	4951
40	104	1529	5016
50	122	1543	5062
60	140	1551	5089
70	158	1555	5102
80	176	1554	5098
90	194	1550	5085
100	212	1543	5062
110	230	1532	5026
120	248	1519	4984
130	266	1503	4931
140	284	1485	4872
150	302	1466	4810
160	320	1440	4724
170	338	1412	4633
180	356	1390	4560
190	374	1360	4462
200	392	1333	4373
220	428	1268	4160
240	464	1192	3911
260	500	1110	3642

## **SIG STR - Signal strength (Reported by Firmware)**

The SIG STR value is a relative indication of the amount of ultrasound making it from the transmitting transducer to the receiving transducer. The signal strength is a blending of esoteric transit time measurements distilled into a usable overall reference.

The measurement of signal strength assists service personnel in troubleshooting the UTM10 system. In general, expect the signal strength readings to be greater than 5 on a full pipe with the transducers properly mounted. Signal strength readings that are less than 5 indicate a need to choose an alternative mounting method for the transducers or that an improper pipe size has been entered.

Signal strength below the Low Signal Cut-off (SIG C-OFF) value will generate a 0010 error (Low Signal Strength) and require either a change in the SIG C-OFF value or transducer mounting changes.

**Note:** If the unit is configured to display totalizer values, the display will alternate between ERROR 0010 and the totalizer value.

Signal strength readings in excess of 98 may indicate that a mounting method with a longer path length may be required. For example, if transducers mounted on a 75 mm (3") PVC pipe in V-mount cause the measured signal strength value to exceed 98, change the mounting method to W-mount for greater stability in readings.

Because signal strength is not an 'absolute' indication of how well a UTM10 flow meter is functioning, there is no real advantage to a signal strength of 50 over a signal strength of 10.

### **TEMP 1 - Temperature of RTD 1 (Reported by Firmware in °C)**

When RTD is selected from the CH2 menu and RTDs are connected to the UTM10-E energy flow meter, the firmware will display the temperature measured by RTD 1 in °C.

### **TEMP 2 - Temperature of RTD 2 (Reported by Firmware in °C)**

When RTD is selected from the CH2 menu and RTDs are connected to the UTM10-E energy flow meter, the firmware will display the temperature measured by RTD 2 in °C.

### **TEMPDIFF - Temperature difference (Reported by Firmware in °C)**

When RTD is selected from the CH2 menu and RTDs are connected to the UTM10-E energy flow meter, the firmware will display the difference in temperature measured between RTD 1 and RTD 2 in °C.

## **TEMP 1 C**

### **Temperature of RTD 1**

Reported by the firmware in C°. When RTD is selected from the CH2 menu and RTDs are connected to the Energy model, the firmware will display the temperature measured by RTD 1 in °C.

## **TEMP 1 F**

### **Temperature of RTD 1**

Reported by the firmware in F°. When RTD is selected from the CH2 menu and RTDs are connected to the Energy model, the firmware will display the temperature measured by RTD 1 in °F.

## TEMP 2 C

### Temperature of RTD 2

Reported by the firmware in C°. When RTD is selected from the CH2 menu and RTDs are connected to the Energy model, the firmware will display the temperature measured by RTD 2 in ° C.

## TEMP 2 F

### Temperature of RTD 2

Reported by the firmware in F°. When RTD is selected from the CH2 menu and RTDs are connected to the Energy model, the firmware will display the temperature measured by RTD 2 in ° F.

## TEMP DIFF C

### Temperature difference

Reported by the firmware in C°. When RTD is selected from the CH2 menu and RTDs are connected to the Energy model, the firmware will display the difference in temperature measured between RTD 1 and RTD 2 in ° C.

## TEMP DIFF F

### Temperature difference

Reported by the firmware in F°. When RTD is selected from the CH2 menu and RTDs are connected to the Energy model, the firmware will display the difference in temperature measured between RTD 1 and RTD 2 in ° F.

## SIG C-OF - Low signal cut-off (Value)

0.0 - 100.0

The SIG C-OF is used to drive the flow meter and its outputs to the SUB FLOW (Substitute Flow described below) state if conditions occur that cause low signal strength. A signal strength indication below 5 is generally inadequate for measuring flow reliably, so the minimum setting for SIG C-OF is 5. A good practice is to set the SIG C-OF at approximately 60-70% of actual measured maximum signal strength.

**Note:** The factory default 'Signal strength cut-off' is 5.

If the measured signal strength is lower than the SIG C-OF setting, an error 0010 will be displayed on the UTM10 display until the measured signal strength becomes greater than the cut-off value.

A signal strength indication below 2 is considered to be no signal at all. Verify that the pipe is full of liquid, the pipe size and liquid parameters are entered correctly, and that the transducers have been mounted accurately. Highly aerated liquids will also cause low signal strength conditions.

## SUB FLOW - Substitute flow (Value)

### 0.0 - 100.0

Substitute Flow (SUB FLOW) is a value that the analog outputs and the flowrate display will indicate when an error condition in the flow meter occurs. The typical setting for this entry is a value that will make the instrument display zero flow during an error condition.

Substitute flow is set as a percentage between MIN RATE and MAX RATE. In a unidirectional system, this value is typically set to zero to indicate zero flow while in an error condition. In a bidirectional system, the percentage can be set such that zero is displayed in a error condition. To calculate where to set the substitute flow value in a bidirectional system, perform the following calculation:

$$\text{Substitute flow} = 100 - \frac{100 \times \text{Maximum flow}}{\text{Maximum flow} - \text{Minimum flow}}$$

Table 12 lists some typical settings to achieve 'Zero' with respect to MIN RATE and MAX RATE settings.

**Table 12 Sample substitute flow readings**

Minimum rate setting	Maximum rate setting	Sub flow setting	Display reading during errors
0.0	1 000.0	0.0*	0.000
-500.0	500.0	50.0*	0.000
-100.0	200.0	33.3*	0.000
0.0	1 000.0	-5.0*	-50.000

\*The software utility is required to set values outside of 0.0-100.0.

## SET ZERO - Set zero flow point (Choice)

NO  
YES

Because every flow meter installation is slightly different and sound waves can travel in slightly different ways through these various installations, it is important to remove the zero offset at zero flow to maintain the flow meter's accuracy. A provision is made using this entry to establish 'Zero' flow and eliminate the offset.

### Procedure:

- 1) The pipe must be full of liquid.
- 2) Flow must be absolute zero - securely close any valves and allow time for any settling to occur.
- 3) Press ENTER, use the arrow ▲▼ keys to make the display read YES.
- 4) Press ENTER.

## D-FLT 0 - Set default zero point (Choice)

NO  
YES

If the flow in a piping system cannot be shut off, allowing the SET ZERO procedure described above to be performed or if an erroneous 'zero' flow was captured - like can happen if SET ZERO is conducted with flowing fluid, then the factory default zero should be utilized. To utilize the D-FLT 0 function, simply press ENTER, then press an arrow ▲▼ key to display YES on the display and then press ENTER.

The default zero places an entry of zero (0) into the firmware instead of the actual zero offset entered by using the SET ZERO procedure.

## **COR FTR - Correction factor (Value)**

**0.500 - 1.500**

This function can be used to make the UTM10 agree with a different or reference flow meter by applying a correction factor / multiplier to the readings and outputs. A factory calibrated system should be set to 1.000. The range of settings for this entry is 0.500 to 1.500. The following examples describe two uses for the COR FTR entry:

- 1) The UTM10 flow meter is indicating a flowrate that is 4% higher than another flow meter located in the same pipeline. To make the UTM10 indicate the same flowrate as the other flow meter, enter a COR FTR of 0.960 to lower the readings by 4%.
- 2) An out-of-round pipe, carrying water, causes the UTM10 to indicate a measured sound speed that is 7.4% lower than the Table 10 value. This pipe condition will cause the flow meter to indicate flowrates that are 7.4% lower than actual flow. To correct the flow readings, enter 1.074.

## **7.11 DSP menu - Display menu**

The DISPLAY menu parameters control what is shown on the display and the rate at which displayed items alternate (dwell time).

### **Display submenu - Display options**

**DISPLAY - Display (Choice)**

**FLOW**

**TOTAL**

**BOTH**

The UTM10 will only display the flowrate with the DISPLAY set to FLOW - it will not display the total flow. The flow meter will only display the total flow with the DISPLAY set to TOTAL - it will not display the flowrate. By selecting BOTH, the display will alternate between FLOW and TOTAL at the interval selected in SCN DWL (see below).

### **Total Submenu - Totalizer choices**

**TOTAL - Totalizer options (Choice)**

**POS - Positive flow only**

**NEG - Negative flow only**

**NET - Net flow**

**BATCH - Batch mode**

Select POS to view the positive direction total only. Select NEG to view the negative direction total only. Select NET to display the net difference between the positive direction and negative direction totals. Select the BATCH to configure the totalizer to count up to a value that is entered as BTCH MUL. After reaching the BTCH MUL value, the display will return to zero and will repeat counting to the BTCH MUL value.

### **Display dwell time**

**SCN DWL - Dwell time (Value)**

**1 to 10 (in Seconds)**

Adjustment of SCN DWL sets the time interval that the display will dwell at FLOW and then alternately TOTAL values when BOTH is chosen from the display submenu. This adjustment range is from 1 second to 10 seconds.



## Totalizer batch quantity

### **BTCH MUL - Batch multiplier (Value)**

If BATCH was chosen for the totalizer mode, a value for batch accumulation must be entered. This is the value to which the totalizer will accumulate before resetting to zero and repeating the accumulation. This value includes any exponents that were entered in the BSC MENU as TOTAL E.

For example:

- 1) If BTCH MUL is set to 1000, RATE UNT to LITRES and TOTL E to E0 (litres  $\times$  1), then the batch totalizer will accumulate to 1000 litres, return to zero and repeat indefinitely. The totalizer will increment 1 count for every 1 litre that has passed.
- 2) If BTCH MUL is set to 1000, RATE UNT to LITRES and TOTL E to E2 (litres  $\times$  100), then the batch totalizer will accumulate to 100 000 litres, return to zero and repeat indefinitely. The totalizer will only increment 1 count for every 100 litres that has passed.

# 8. Software utility

## 8.1 Introduction

In addition to or as a replacement for the keypad entry programming, the UTM10 flow meter can be used with a software utility. The software utility is used for configuring, calibrating and communicating with the UTM10 family of flow meters. Additionally, it has numerous troubleshooting tools to make diagnosing and correcting installation problems easier.

This software has been designed to provide the UTM10 user with a powerful and convenient way to configure calibrate and troubleshoot all UTM10 family flow meters. A PC can be hard-wired to a UTM10 flow meter through a standard USB connection found on most current computers.

## 8.2 System requirements

The software requires a PC-type computer, running Windows 7, Windows XP or Windows Vista® operating systems and a USB communications port.

## 8.3 Installation

- 1) From the Windows 'Start' button, choose the Run command. From the 'Run' dialog box, use the Browse button to navigate to the USP\_Setup.exe file and double-click.
- 2) The USP Setup will automatically extract and install on the hard disk. The USP icon can then be copied to the desktop, if desired.

**Note:** If a previous version of this software is installed, it must be un-installed before a new version of the software can be installed. Newer versions will 'ask' to remove the old version and perform the task automatically. Older versions must be removed using the Microsoft Windows® Add/Remove Programs applet.

**Note:** Most PCs will require a restart after a successful installation.

## 8.4 Initialization

- 1) Connect the B end of the USB A/B communications cable to the UTM10 USB communication port and the A end to a convenient USB port on the computer.

**Note:** It is advisable to have the UTM10 flow meter powered up prior to running this software.

**Note:** While the USB cable is connected, the RS485 and frequency outputs are disabled.

- 2) Double-click on the USP icon. The first screen is the 'RUN' mode screen (see Figure 43), which contains real-time information regarding flowrate, totals, signal strength, communications status, and the flow meter's serial number. The COMM indicator in the lower right-hand corner indicates that the serial connection is active. If the COMM box contains a red ERROR, click on the Communications button on the Menu bar and select Initialize. Choose the appropriate COM port and the RS232 / USB Com Port Type. Proper communication is verified when a green OK is indicated in the lower right-hand corner of the PC display and the 'Last Update' indicator in the text area on the left side of the screen changes from red to an active clock indication.

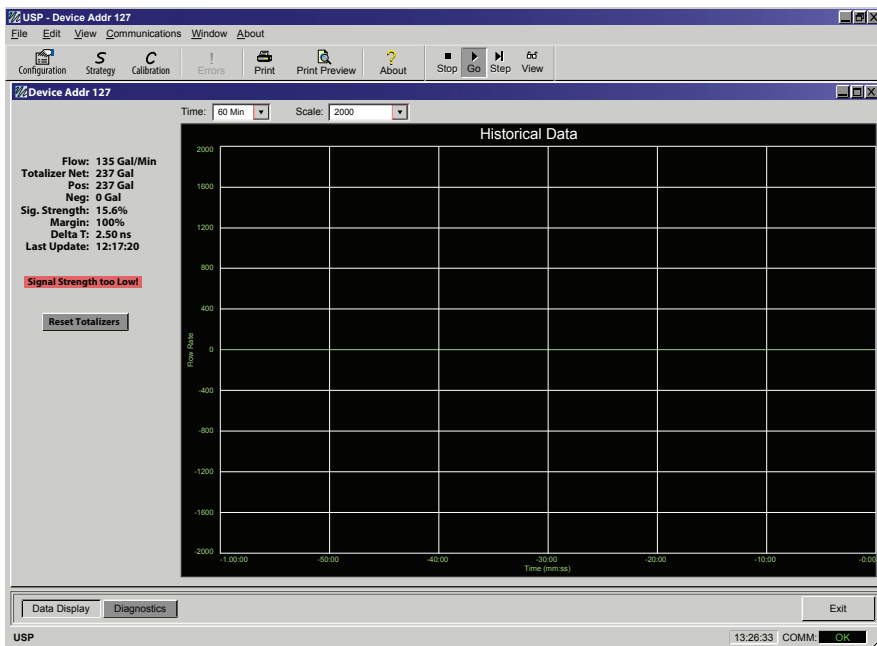

**Fig. 41 Data display screen**



Configuration

The Configuration drop-down houses six screens used to control how the UTM10 is set-up and responds to varying flow conditions. The first screen that appears after clicking the Configuration button is the Basic screen. See *Fig. 42 on page 72*.

## 8.5 Basic tab

### General

The general heading allows users to select the measurement system for UTM10 set-up, either Metric (mm) or Imperial (inches) and choose from a number of pre-programmed small pipe configurations in the Standard Configurations drop-down. If pipe measurements are to be entered in mm, select Metric. If the General entries are altered from those at instrument start-up, then click on the Download button in the lower right-hand portion of the screen and cycle power to the UTM10.

When using the Standard Configurations drop-down menu alternate, menu choices can be made by using the following guidelines:

- 1) Select the transducer type and pipe size for the transducer to be used. The firmware will automatically enter the appropriate values for that pipe size and type. Every entry parameter except for Units, MODBUS Address, Standard Configurations, Frequency, Flow Direction, and Specific Heat Capacity will be unavailable behind a 'grayed out' entry box.
- 2) Go back to the Standard Configurations drop-down menu and select Custom. As soon as Custom is chosen, the previously grayed out selections will become available for editing.

- 3) Make any changes to the Basic configuration deemed necessary and press Download.
- 4) To ensure that the configuration changes take effect, turn the power off and then back on again to the transmitter.

Also under the General heading is a field for entering a MODBUS Address. If the UTM10 is to be used on a multi-drop RS485 network, it must be assigned a unique numerical address. This box allows that unique address to be chosen.

**Note:** This address does not set the Modbus TCP/IP, EtherNet/IP™, BACnet® address. That is set via the web page interface that is integrated into the Ethernet port.

**Note:** Do not confuse the MODBUS Address with the 'Device Address' as seen in the upper left-hand corner of the display. The Device Addr is included for purposes of backward compatibility of first generation UTM10 products. The Device Addr has no function and will not change when used with a UTM10.

### Transducer

Transducer Type selects the transducer that will be connected to the UTM10 flow meter. Select the appropriate transducer type from the drop-down list. This selection influences transducer spacing and flow meter performance, so it must be correct. If you are unsure about the type of transducer to which the UTM10 will be connected, consult the shipment packing list or call the manufacturer for assistance.

**Note:** A change of Transducer Type will cause a System Configuration Error (1002: Sys Config Changed) to occur. This error will clear when the microprocessor is reset or power is cycled on the flow meter.

Transducer Mount selects the orientation of the transducers on the piping system. See "Transmitter installation" on page 12 and Table 2 on page 19 for detailed information regarding transducer mounting modes for particular pipe and liquid characteristics. Whenever Transducer Mount is changed, a download command and subsequent microprocessor reset or flow meter power cycle must be conducted.

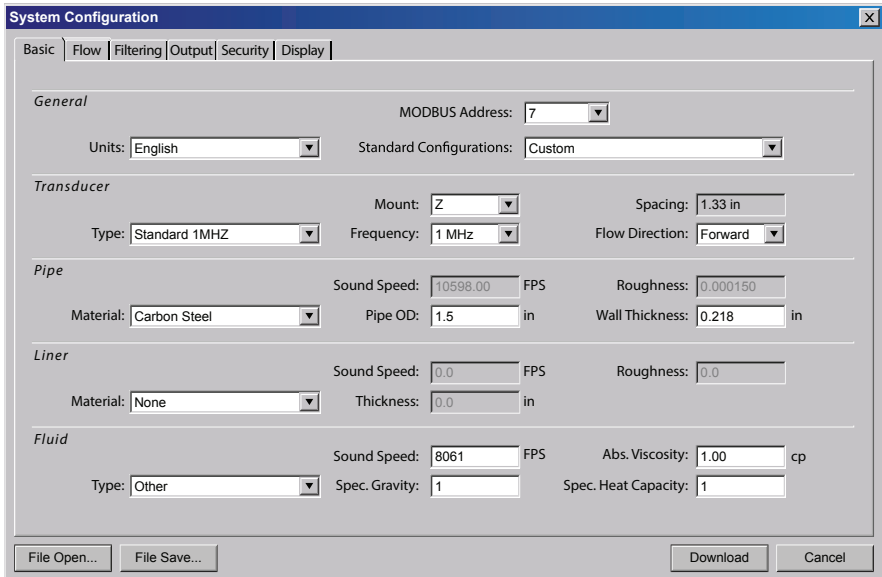

Fig. 42 Basic tab

Transducer Frequency permits the UTM10 to select a transmission frequency for the various types of transducers that can be utilized. In general, the larger the pipe the slower the transmission frequency needs to be to attain a good signal.

**Table 13 Transducer frequencies**

Frequency	Transducers	Transmission modes	Pipe size and type
<b>2 MHz</b>	All 15 mm - 40 mm (½" - 1½") UTT10-015S to UTT10-040S	Selected by firmware	Specific to transducer
<b>1 MHz</b>	UTT10-050S and UTT10-050H	W, V, and Z	50 mm (2") and greater
<b>500 KHz</b>	UTT10-050L	W, V, and Z	600 mm (24") and greater

**Transducer spacings**

Transducer spacing is a value calculated by the UTM10 firmware that takes into account pipe, liquid, transducer and mounting information. This spacing will adapt as these parameters are modified. If Metric was chosen as your choice of units the spacing will be given in millimetres. This value is the lineal distance that must be between the transducer alignment marks. Selection of the proper transducer mounting method is not entirely predictable and many times is an iterative process.

**Note:** This setting only applies to UTT10-050S, UTT10-050L and UTT10-050H transducers.

**Transducer flow direction**

Allows the flow direction to be changed from that which the flow meter assumes to be forward. This feature allows upstream and downstream transducers to be 'electronically' reversed making upside down mounting of the display unnecessary when mounting a UTM10 flow meter with integral transducer.

**Pipe material**

Pipe material is selected from the pull-down list. If the pipe material utilized is not found in the list, select Other and enter the actual pipe material Sound Speed and Roughness (much of this information is available at web sites such as [www.ondacorp.com/tecref\\_acousticstable.html](http://www.ondacorp.com/tecref_acousticstable.html)) for pipe relative roughness calculations.

**Pipe O.D. and wall thickness**

Pipe O.D. and wall thickness are based on the physical dimensions of the pipe on which the transducers will be mounted. If Metric is your units of choice enter this value in millimetres.

**Note:** Charts listing popular pipe sizes have been included in "Appendix" on page 88. Correct entries for pipe O.D. and pipe wall thickness are critical to obtaining accurate flow measurement readings.

**Liner material**

Liner material is selected from the pull-down list. If the pipe liner material utilized is not included in the list, select Other and enter liner material Sound Speed and Roughness (much of this information is available at web sites such as [www.ondacorp.com/tecref\\_acousticstable.html](http://www.ondacorp.com/tecref_acousticstable.html)). See "Liner roughness" on page 52 for pipe liner relative roughness calculations.

## Fluid type

Fluid type is selected from a pull-down list. If the liquid is not found in the list, select Other and enter the liquid Sound Speed and Absolute Viscosity into the appropriate boxes. The liquid's Specific Gravity is required if mass measurements are to be made, and the Specific Heat Capacity is required for energy measurements.

## 8.6 Flow tab

**Flowrate Units** are selected from the drop-down lists. Select an appropriate rate unit and time from the two lists. This entry also includes the selection of Flowrate Interval after the / sign.

**Totalizer Units** are selected from drop-down lists. Select an appropriate totalizer unit and totalizer exponent. The totalizer exponents are in scientific notation and permit the eight digit totalizer to accumulate very large values before the totalizer 'rolls over' and starts again at zero. *Table 9 on page 56* illustrates the scientific notation values and their respective decimal equivalents.

The screenshot shows a 'System Configuration' dialog box with the 'Flow' tab selected. The 'Flow Rate Units' are set to 'Gallons' and 'Min'. The 'Totalizer Units' are set to 'Gallons' and 'X10'. The 'Min Flow' is set to '0.0 Gal/M' and the 'Max Flow' is set to '400.0 Gal/M'. The 'Low Flow Cutoff' is set to '2%', the 'Low Signal Cutoff' is set to '2%', and the 'Substitute Flow' is set to '0%'. At the bottom, there are buttons for 'File Open...', 'File Save...', 'Download', and 'Cancel'.

Fig. 43 Flow tab

**Min Flow** is the minimum volumetric flowrate setting entered to establish filtering parameters. Volumetric entries will be in the flowrate units. For unidirectional measurements, set Min Flow to zero. For bidirectional measurements, set Min Flow to the highest negative (reverse) flowrate expected in the piping system.

**Max Flow** is the maximum volumetric flowrate setting entered to establish filtering parameters. Volumetric entries will be in the flowrate units. For unidirectional measurements, set Max Flow to the highest (positive) flowrate expected in the piping system. For bidirectional measurements, set Max Flow to the highest (positive) flowrate expected in the piping system.

**Low Flow Cut-off** is provided to allow very low flowrates (that can be present when pumps are off and valves are closed) to be displayed as zero flow. Typical values that should be entered are between 1.0% and 5.0% of the flow range between Min Flow and Max Flow.

**Low Signal Cut-off** is used to drive the flow meter and its outputs to the value specified in the Substitute Flow field when conditions occur that cause low signal strength. A signal strength indication below 5 is generally inadequate for measuring flow reliably, so generally the minimum setting for Low Signal Cut-off is 5. A good practice is to set the Low Signal Cut-off at approximately 60-70% of actual measured maximum signal strength.

**Note:** The factory default 'Low Signal Cut-off' is 5.

If the measured signal strength is lower than the Low Signal Cut-off setting, a 'Signal Strength too Low' highlighted in red will become visible in the text area to the left in the Data Display screen until the measured signal strength becomes greater than the cut-off value.

Signal strength indication below 2 is considered to be no signal at all. Verify that the pipe is full of liquid, the pipe size and liquid parameters are entered correctly, and that the transducers have been mounted accurately. Highly aerated liquids will also cause low signal strength conditions.

**Substitute Flow** is a value that the analog outputs and the flowrate display will indicate when an error condition in the flow meter occurs. The typical setting for this entry is a value that will make the instrument display zero flow during an error condition.

Substitute Flow is set as a percentage between Min Flow and Max Flow. In a unidirectional system, this value is typically set to zero to indicate zero flow while in an error condition. In a bidirectional system, the percentage can be set such that zero is displayed in an error condition. To calculate where to set the Substitute Flow value in a bidirectional system, perform the following operation:

$$\text{Substitute flow} = 100 - \frac{100 \times \text{Maximum flow}}{\text{Maximum flow} - \text{Minimum flow}}$$

Entry of data in the Basic and Flow tabs is all that is required to provide flow measurement functions to the flow meter. If the user is not going to utilize input/output functions, click on the Download button to transfer the configuration to the UTM10 instrument. When the configuration has been completely downloaded, turn the power to the flow meter off and then on again to guarantee the changes take effect.

## 8.7 Filtering tab

The Filtering tab contains several filter settings for the UTM10 flow meter. These filters can be adjusted to match response times and data 'smoothing' performance to a particular application.

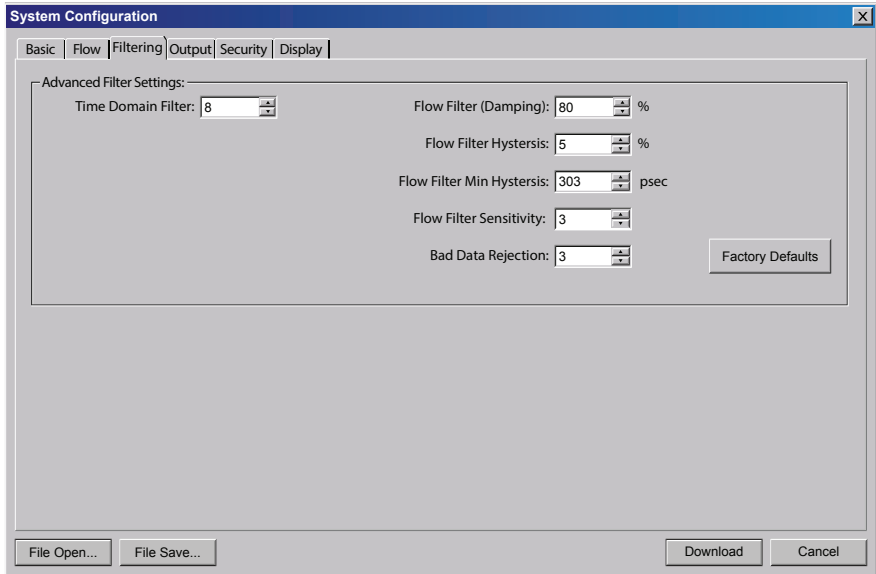

Fig. 44 Filtering tab

**Time Domain Filter (range 1-256)** adjusts the number of raw data sets (the wave forms viewed on the software Diagnostics Screen) that are averaged together. Increasing this value will provide greater damping of the data and slow the response time of the flow meter. Conversely, lowering this value will decrease the response time of the meter to changes in flow/energy rate. This filter is not adaptive, it is operational to the value set at all times.

**Note:** The UTM10 completes a measurement in approximately 350 - 400 milliseconds. The exact time is pipe size dependent.

Short Pulse Duration is a function used on pipes larger than 200 mm (8"). The Short Pulse is utilized by the UTM10 to measure course transmit-time delays on larger pipes, which permits the flow meter to operate without having the DSP chip run an excess of fine transmit delay correlations. The result is that the flow meter's processing time is used more efficiently. If the flow meter did not operate with a course transmit-time delay, the flow meter would be forced to run unnecessary cross correlation calculations and the data throughput per second would be radically reduced. Without the Short Pulse feature the potential for peak-hopping would also be greatly increased.

A shorter pulse than the standard pulse loaded through the Strategy window determined by the Short Pulse setting or calculated automatically is transmitted periodically during the measurement cycle. This pulse is suitable for measuring course transit-time, but does not have enough resolution to display flow. When the pipe is small, the potential for peak-hopping is reduced to zero, because difference time never gets to be greater than 180° of phase shift or 2 MHz (250 ns) or 1 MHz (500 ns), so course transit-time delays are not required.



The Short Pulse function does not operate until the combination of fluid velocity, transducer mounting method and pipe size warrant, and this is typically if a delta T time in excess of 1 MHz (500 ns) is anticipated. (The software determines this possibility from the pipe size and flowrates that are entered by the user.)

**Note:** There are some very, very rare occasions that the Short Pulse value would need to be manipulated, but generally just changing the transmitted wave forms through the use of 'Strategies' works better than altering the Short Pulse numbers.

**Flow Filter (Damping)** establishes a maximum adaptive filter value. Under stable flow conditions (flow that varies less than the Flow Filter Hysteresis entry), this adaptive filter will increase the number of successive flow readings that are averaged together up to this maximum value. If flow changes outside of the Flow Filter Hysteresis window, the filter adapts by decreasing the number of averaged readings and allows the flow meter to react faster.

The damping value is increased to increase stability of the flowrate readings. Damping values are decreased to allow the flow meter to react faster to changing flowrates. The factory settings are suitable for most installations. Increasing this value tends to provide smoother steady-state flow readings and outputs.

**Flow Filter Hysteresis** creates a window around the average flow measurement reading allowing small variations in flow without changing the damping value. If the flow varies within that hysteresis window, greater display damping will occur up to the maximum values set by the Flow Filter (Damping) entry. The filter also establishes a flowrate window where measurements outside of the window are examined by the Bad Data Rejection filter. The value is entered as a percentage of actual flowrate.

For example, if the average flowrate is 100 litres/minute (LPM) and the Flow Filter Hysteresis is set to 5%, a filter window of 95 - 105 litres/minute (LPM) is established. Successive flow measurements that are measured within that window are recorded and averaged in accordance with the Flow Filter Damping setting. Flow readings outside of the window are held up in accordance with the Bad Data Rejection filter.

**Flow Filter MinHysteresis** sets a minimum hysteresis window that is invoked at sub 0.08 metres/second 'MPS' (0.25 feet/second 'FPS') flowrates, where the 'of rate' Flow Filter Hysteresis is very small and ineffective. This value is entered in pico-seconds ( $\rho$  sec) and is differential time. If very small fluid velocities are to be measured, increasing the Flow Filter MinHysteresis value can increase reading stability.

**Flow Filter Sensitivity** allows configuration of how fast the Flow Filter Damping will adapt in the positive direction. Increasing this value allows greater damping to occur faster than lower values. Adaptation in the negative direction is not user adjustable.

**Bad Data Rejection** is a value related to the number of successive readings that must be measured outside of the Flow Filter Hysteresis or Flow Filter MinHysteresis windows before the flow meter will use that flow value. Larger values are entered into Bad Data Rejection when measuring liquids that contain gas bubbles, as the gas bubbles tend to disturb the ultrasonic signals and cause more extraneous flow readings to occur. Larger Bad Data Rejection values tend to make the flow meter more sluggish to rapid changes in actual flowrate.

## 8.8 Output tab

The entries made in the Output tab establish input and output parameters for the flow meter. Select the appropriate function from the pull-down menu and press the Download button. When a function is changed from the factory setting, a Configuration error (1002) will result. This error will be cleared by resetting the UTM10 microprocessor from the Communications/Commands/Reset Target button or by cycling power on the UTM10 flow meter. Once the proper output is selected and the microprocessor is reset, calibration and configuration of the modules can be completed.

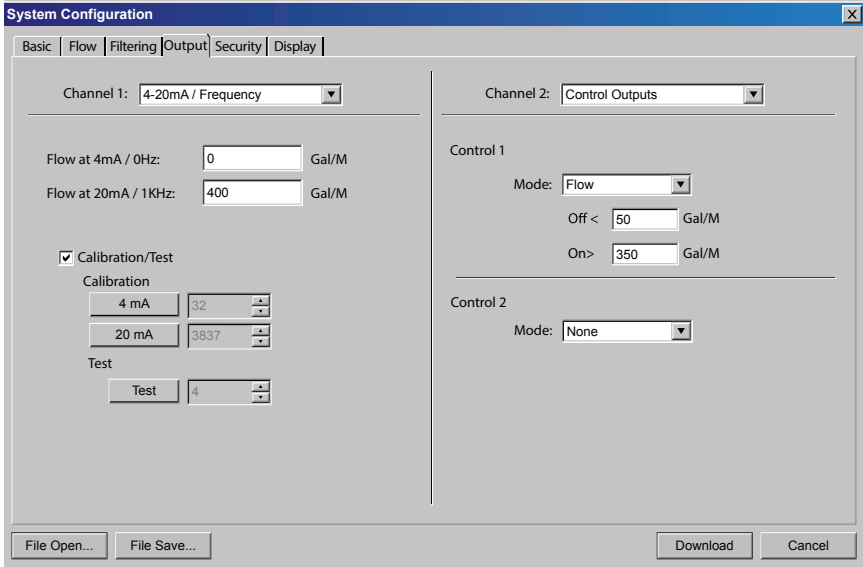

Fig. 45 Output tab

## 8.9 Channel 1 - 4-20 mA configuration

**Note:** The 4-20 mA Output Menu applies to all UTM10 versions and is the only output choice for Channel 1.

The Channel 1 menu controls how the 4-20 mA output is spanned for all UTM10 models and how the frequency output is spanned for the UTM10-S flow model.

The Flow at 4 mA / 0 Hz and Flow at 20 mA / 1000 Hz settings are used to set the span for both the 4-20 mA output and the 0 - 1000 Hz frequency output on the UTM10-S flow meter versions.

The 4-20 mA output is internally powered (current sourcing) and can span negative to positive flow/energy rates. This output interfaces with virtually all recording and logging systems by transmitting an analog current that is proportional to system flowrate. Independent 4 mA and 20 mA span settings are established in firmware using the flow measuring range entries. These entries can be set anywhere in the -12 to +12 metres/second 'MPS' (-40 to +40 feet/second 'FPS') range of the instrument. Resolution of the output is 12-bits (4096 discrete points) and can drive up to a 400 Ohm load when the flow meter is ac powered. When powered by a dc supply, the load is limited by the input voltage supplied to the instrument. See Figure 24, page 27, for allowable loop loads.

**Flow at 4 mA / 0 Hz**

**Flow at 20 mA / 1000 Hz**

The Flow at 4 mA / 0 Hz and Flow at 20 mA/1000 Hz entries are used to set the span of the 4-20 mA analog output and the frequency output on UTM10-S flow meter versions. These entries are volumetric rate units that are equal to the volumetric units configured as rate units and rate interval discussed on Page 49.

**Example 1** - To span the 4-20 mA output from -100 litres/minute 'GPM' to +100 litres/minute 'LPM' with 12 mA being 0 litres/minute 'LPM', set the Flow at 4 mA/0 Hz and Flow at 20 mA / 1000 Hz inputs as follows:

**Flow at 4 mA / 0 Hz = -100.0**

**Flow at 20 mA / 1 000 Hz = 100.0**

If the flow meter were a UTM10-S, this setting would also set the span for the frequency output. At -100 litres/minute 'LPM', the output frequency would be 0 Hz. At the maximum flow of 100 litres/minute 'LPM', the output frequency would be 1000 Hz, and in this instance a flow of zero would be represented by an output frequency of 500 Hz.

**Example 2** - To span the 4-20 mA output from 0 litres/minute 'LPM' to +100 litres/minute 'LPM' with 12 mA being 50 litres/minute 'LPM', set the Flow at 4 mA/0 Hz and Flow at 20 mA/1000 Hz inputs as follows:

**Flow at 4 mA / 0 Hz = 0.0**

**Flow at 20 mA / 1 000 Hz = 100.0**

For the UTM10-S flow meter, in this instance, zero flow would be represented by 0 Hz and 4 mA.

The full-scale flow or 100 litres/minute 'LPM' would be 1000 Hz and 20 mA and a midrange flow of 50 litres/minute 'LPM' would be expressed as 500 Hz and 12 mA

The 4-20 mA output is factory calibrated and should not require adjustment. If small adjustments to the DAC (Digital to Analog Converter) are needed, for instance if adjustments due to the accumulation of line losses from long output cable lengths are required, the Calibration 4 mA and Calibration 20 mA can be used.

**Calibration 4 mA - 4 mA DAC calibration entry (Value)**

**Calibration 20 mA- 20 mA DAC calibration entry (Value)**

The Calibration 4 mA and Calibration 20 mA entries allows fine adjustments to be made to the 'zero' and full-scale of the 4-20 mA output. To adjust the outputs, an ammeter or reliable reference connection to the 4-20 mA output must be present.

**Note:** Calibration of the 20 mA setting is conducted much the same way as the 4 mA adjustments.

**Note:** The Calibration 4 mA and Calibration 20 mA entries should not be used in an attempt to set the 4-20 mA range. Utilize Flow at 4 mA / 0 Hz and Flow at 20 mA / 1 000 Hz detailed above for this purpose.

**4 mA calibration procedure:**

- 1) Disconnect one side of the current loop and connect the ammeter in series (disconnect either wire at the terminals labeled 4-20 mA Out or Signal Gnd).
- 2) Using the arrow keys, increase the numerical value to increase the current in the loop to 4 mA. Decrease the value to decrease the current in the loop to 4 mA. Typical values range between 40 - 80 counts.
- 3) Reconnect the 4 - 20 mA output circuitry as required.

20 mA calibration procedure:

- 1) Disconnect one side of the current loop and connect the ammeter in series (disconnect either wire at the terminals labeled 4 - 20 mA Out or Signal Gnd).
- 2) Using the arrow keys, increase the numerical value to increase the current in the loop to 20 mA. Decrease the value to decrease the current in the loop to 20 mA. Typical values range between 3700 - 3900 counts.
- 3) Reconnect the 4 - 20 mA output circuitry as required.

**4 - 20 Test - 4 - 20 mA output test (Value)**

Allows a simulated flow value to be sent from the 4-20 mA output. By incrementing this value, the 4-20 mA output will transmit the indicated current value.

## 8.10 Channel 2 - RTD configuration UTM10-E only

**Note:** The Channel 2 Menu is used to configure model specific I/O options. The UTM10-S flow meter presents a different set of parameters than the UTM-E flow meter.



**Caution:** It is possible to choose options pertaining only to the UTM10-S flow meter when a UTM10-E flow meter is present. The opposite is also true. The proper menu type must be chosen for the actual flow meter. If this caution isn't followed, the outputs or flow meter readings will be unpredictable.

Inputs from two 1 000 Ohm platinum RTD temperature sensors allow the measurement of energy delivered in liquid heating and cooling systems.

The values used to calibrate the RTD temperature sensors are derived in the laboratory and are specific to a specific RTD. The RTDs on new units come with the calibration values already entered into the UTM10 and should not need to be changed.

Field replacement of RTDs is possible through the use of the keypad or the software. If the RTDs were ordered from the manufacturer, they will come with calibration values that need to be loaded into the UTM10.

**RTD calibration procedure:**

- 1) Enter the calibration values for RTD #1 A and B followed by RTD #2 A and B.
- 2) Double-click on the Download button to send the values to memory.
- 3) Turn the power off and then back on to the UTM10 to enable the changes to take effect.

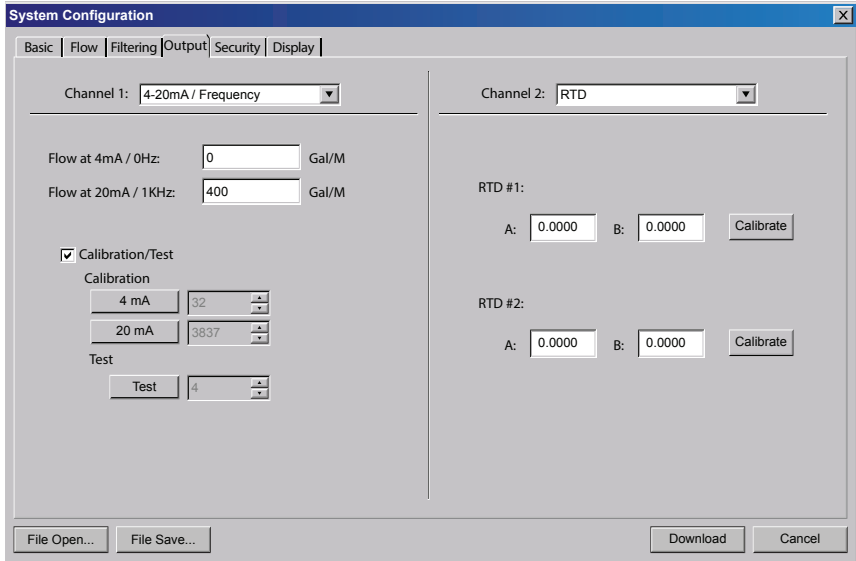

**Fig. 46 Channel 2 input (RTD)**

New, non-calibrated RTDs will need to be field calibrated using an ice bath and boiling water to derive calibration values. This procedure is outlined in "*In field calibration of RTD temperature sensors*" on page 100.

## 8.11 Channel 2 - Control output configuration UTM10-S only

Two independent open collector transistor outputs are included with the UTM10-S flow meter. Each output can be configured independently to 'Alarm' for one of the following. See "Alarm output" on page 34..

- None
- Batch / Total
- Flow
- Signal Strength
- Errors

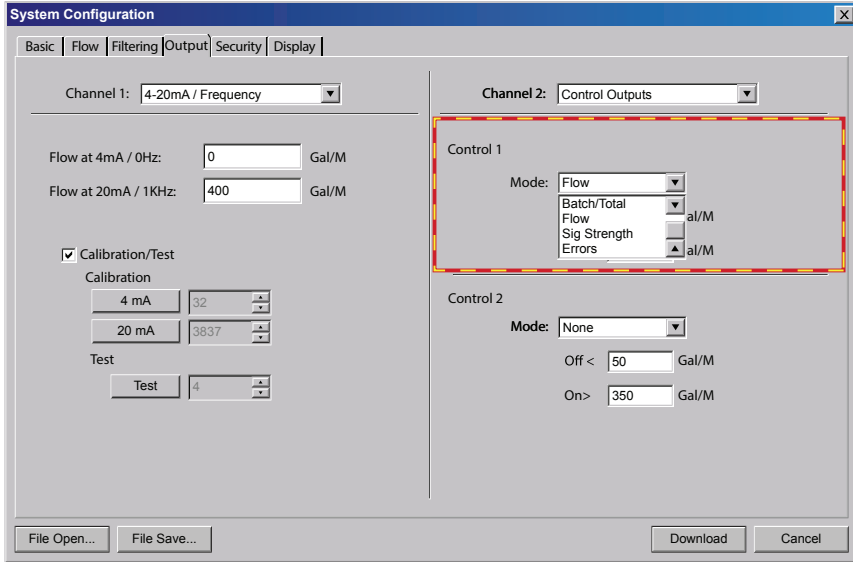

Fig. 47 Channel 2 output choices

### None

All alarm outputs are disabled.

### Batch / Total

Multiplier (Value)

This is the value to which the totalizer will accumulate before resetting to zero and repeating the accumulation. This value includes any exponents that were entered in the BSC MENU as TOTAL E. See "Alarm output" on page 34.

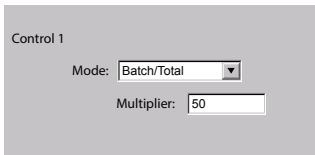

## Flow

### ON (Value)

Sets value at which the alarm output will switch from OFF to ON.

### OFF (Value)

Sets value at which the alarm output will switch from ON to OFF.

Control 1

Mode:

Off <  Gal/M

On >  Gal/M

## Signal strength

### ON (Value)

Sets value at which the alarm output will turn ON.

### OFF (Value)

Sets value at which the alarm output will turn OFF.

Control 1

Mode:

Off <

On >

## Errors

Alarm outputs on any error condition. See "*UTM10 error codes*" on page 105.

## 8.12 Setting zero and calibration

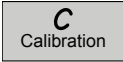

The software utility contains a powerful multi-point calibration routine that can be used to calibrate the UTM10 flow meter to a primary measuring standard in a particular installation. To initialize the three-step calibration routine, click on the Calibration button located on the top of the Data Screen. The display shown in *Fig. 48* will appear.

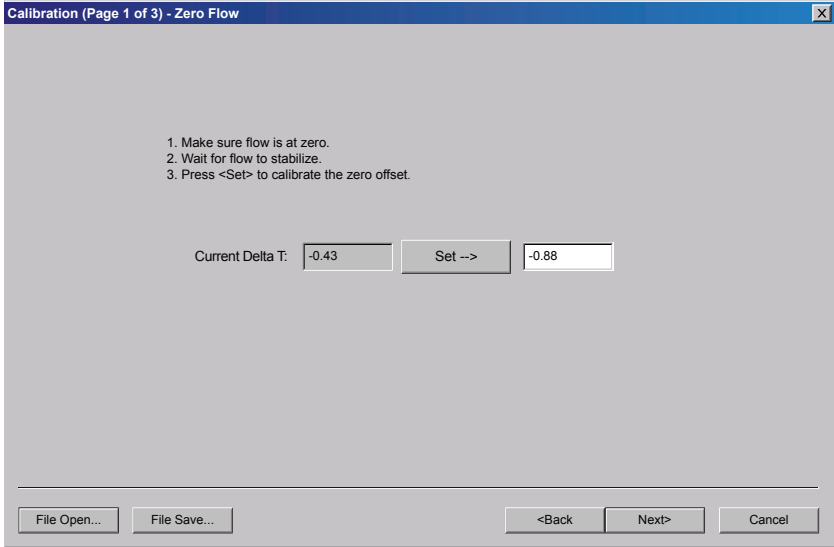

**Fig. 48 Calibration Page 1 of 3**

**Step 1 - The first screen (Page 1 of 3)**, establishes a baseline zero flowrate measurement for the instrument.

Because every flow meter installation is slightly different and sound waves can travel in slightly different ways through these various installations, it is important to remove the zero offset at zero flow to maintain the flow meters accuracy. A provision is made using this entry to establish 'Zero' flow and eliminate the offset.

### To zero the flow meter:

- 1) Establish zero flow in the pipe (ensure that the pipe is full of fluid, turn off all pumps, and close a dead-heading valve). Wait until the delta-time interval shown in 'Current Delta T' is stable (and typically very close to zero).
- 2) Click the Set button.
- 3) Click the Next button when prompted, then click the Finish button on the calibration screen.

The zeroing process is essential in systems using the UTM10-015S to UTM10-040S transducer sets to ensure the best accuracy.



**Step 2 - (Page 2 of 3)** in the calibration process is the selection of the engineering units with which the calibration will be performed. Select the Flowrate Units and click the Next button at the bottom of the window.

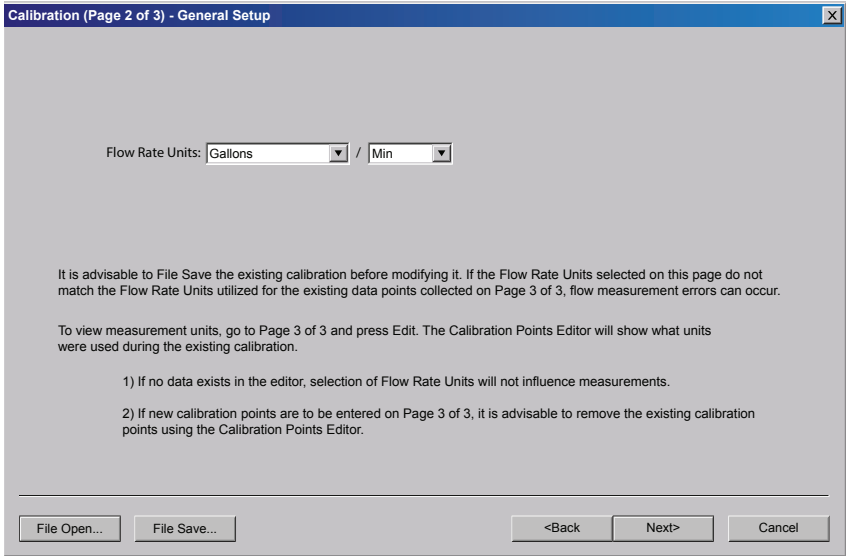

**Fig. 49 Calibration page 2 of 3**

**Step 3 - (Page 3 of 3)** as shown in Figure 49 allows multiple actual flowrates to be recorded by the UTM10. To calibrate a point, establish a stable, known flowrate (verified by a real-time primary flow instrument), enter the actual flowrate in the cell as shown in Figure 49 and click the Set button. Repeat for as many points as desired.

**Note:** If only two points are to be used (zero and span), it is preferable to use the highest flowrate anticipated in normal operation as the calibration point. If an erroneous data point is collected, the point can be removed by pressing the Edit button, selecting the bad point and then selecting Remove.

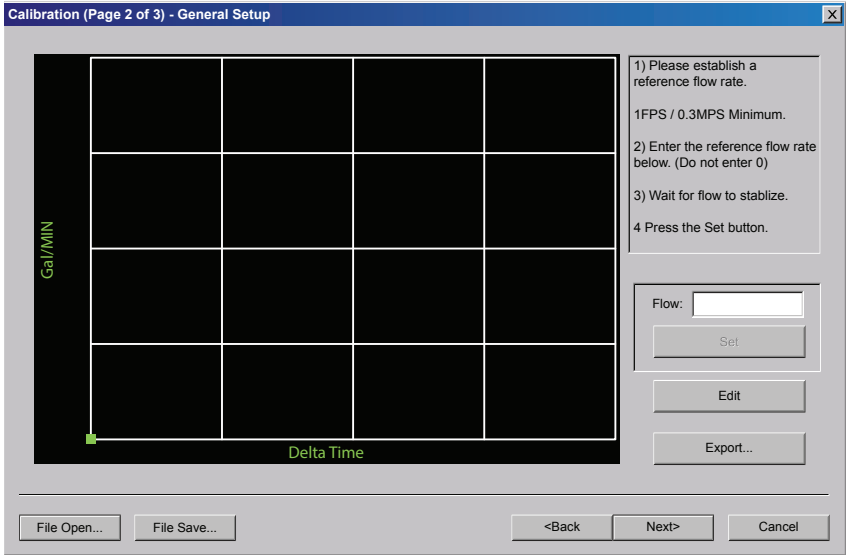

**Fig. 50 Calibration page 3 of 3**

Zero values are not valid for linearization entries. Flowmeter zero is entered on Page 1 of 3. If a zero calibration point is attempted, the following error message will be shown:

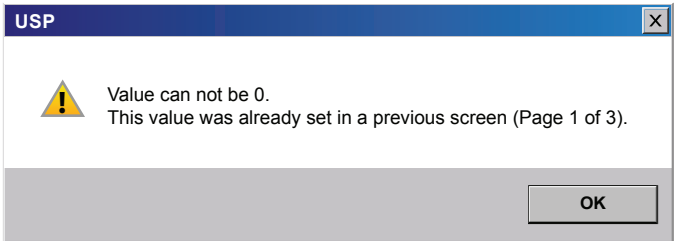

Press the Finish button when all points have been entered.

## 8.13 Target Dbg data screen - Definitions

- 1) Calc count - The number of flow calculations performed by the flow meter beginning at the time the power to the flow meter was last turned off and then on again.
- 2) Sample count - The number of samples currently being taken in one second.
- 3) Raw delta T ( $\eta$ s) - The actual amount of time it takes for an ultrasonic pulse to cross the pipe.
- 4) Course delta T
- 5) Gain - The amount of signal amplification applied to the reflected ultrasound pulse to make it readable by the digital signal processor.
- 6) Gain setting/waveform power - The first number is the gain setting on the digital pot (automatically controlled by the AGC circuit). Valid numbers are from 1 to 100. The second number is the power factor of the current waveform being used. For example, '8' indicates that a 1/8 power wave form is being used.
- 7) Tx delay - The amount of time the transmitting transducer waits for the receiving transducer to recognize an ultrasound signal before the transmitter initiates another measurement cycle.
- 8) Flow filter - The current value of the adaptive filter.
- 9) SS (Min/Max) - The minimum and maximum signal strength levels encountered by the flow meter beginning at the time the power to the flow meter was last turned off and then on again.
- 10) Signal strength state - Indicates if the present signal strength minimum and maximum are within a pre-programed signal strength window.
- 11) Sound speed - The actual sound speed being measured by the transducers at that moment.
- 12) Reynolds - A number indicating how turbulent a fluid is. Reynolds numbers between 0 and 2000 are considered laminar flow. Numbers between 2000 and 4000 are in transition between laminar and turbulent flows and numbers greater than 4000 indicate turbulent flow.
- 13) Reynolds factor - The value applied to the flow calculation to correct for variations in Reynolds numbers.
- 14) Serial number (TFXD) - The serial number reported by firmware.

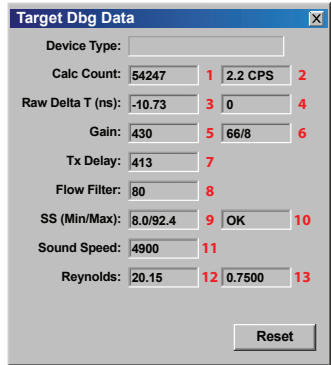

Fig. 51 Target Dbg Data

## 8.14 Saving the flow meter configuration onto a PC

The complete configuration of the flow meter can be saved from the Configuration screen. Select File Save button located in the lower left-hand corner of the screen and name the file. Files are saved as a \*.dcf extension. This file may be transferred to other flow meters or may be recalled should the same pipe be surveyed again or multiple flow meters programmed with the same information.

## 8.15 Printing a flow meter configuration report

Select File from the upper task bar and Print to print a calibration / configuration information sheet for the installation.

# 9. Appendix

## 9.1 Specifications

9.1.1 System	
<b>Liquid types</b>	Most clean liquids or liquids containing small amounts of suspended solids or gas bubbles.
<b>Velocity range</b>	Bidirectional to greater than 12 metres/second (40 feet/second)
<b>Flow accuracy</b>	<p><b>UTT10-050S, UTT10-50H and UTT10-050L:</b>  <math>\pm 1\%</math> of reading at rates <math>&gt; 0.3</math> metres/second (1 feet/second);  <math>\pm 0.003</math> metres/second (0.01 feet/second) at flows <math>&lt; 0.3</math> metres/second (1 feet/second).</p> <p><b>UTT10-015S to UTT10-040S:</b>            25 mm (1") and larger units <math>\pm 1\%</math> of reading from 10 to 100% of measurement range; <math>\pm 0.003</math> metres/second (0.01 feet/second) at lower rates.            Smaller than 25 mm (1") units are <math>\pm 1\%</math> of full-scale.</p>
<b>Flow repeatability</b>	$\pm 0.01\%$ of reading.
<b>Flow sensitivity</b>	$\pm 0.0003$ metres/second (0.001 feet/second)
<b>Temperature accuracy (Energy flow meters only)</b>	<p>Option 1:            0 to <math>+50^{\circ}\text{C}</math> (<math>+32</math> to <math>+122^{\circ}\text{F}</math>); Absolute <math>0.12^{\circ}\text{C}</math> (<math>0.22^{\circ}\text{F}</math>);            Difference <math>0.05^{\circ}\text{C}</math> (<math>0.09^{\circ}\text{F}</math>).</p> <p>Option 2:            0 to <math>+100^{\circ}\text{C}</math> (<math>+32</math> to <math>+212^{\circ}\text{F}</math>); Absolute <math>0.25^{\circ}\text{C}</math> (<math>0.45^{\circ}\text{F}</math>);            Difference <math>0.10^{\circ}\text{C}</math> (<math>0.18^{\circ}\text{F}</math>).</p> <p>Option 3:  <math>-40</math> to <math>+177^{\circ}\text{C}</math> (<math>-40</math> to <math>+350^{\circ}\text{F}</math>); Absolute <math>0.60^{\circ}\text{C}</math> (<math>1.10^{\circ}\text{F}</math>);            Difference <math>0.25^{\circ}\text{C}</math> (<math>0.45^{\circ}\text{F}</math>).</p> <p>Option 4:  <math>-20</math> to <math>+30^{\circ}\text{C}</math> (<math>-4</math> to <math>+86^{\circ}\text{F}</math>); Absolute <math>0.12^{\circ}\text{C}</math> (<math>0.22^{\circ}\text{F}</math>);            Difference <math>0.05^{\circ}\text{C}</math> (<math>0.09^{\circ}\text{F}</math>).</p>
<b>Temperature sensitivity</b>	<p>Option 1: <math>0.012^{\circ}\text{C}</math> (<math>0.03^{\circ}\text{F}</math>).</p> <p>Option 2: <math>0.025^{\circ}\text{C}</math> (<math>0.05^{\circ}\text{F}</math>).</p> <p>Option 3: <math>0.06^{\circ}\text{C}</math> (<math>0.1^{\circ}\text{F}</math>).</p> <p>Option 4: <math>0.012^{\circ}\text{C}</math> (<math>0.03^{\circ}\text{F}</math>).</p>
<b>Temperature repeatability</b>	$\pm 0.5\%$ of reading.

## 9.1.2 Transducers

<b>Liquid types</b>	Most non-aerated, clean liquids.
<b>Cable length</b>	Up to 300 meters (990 ft) Standard lengths 6, 15, 30 meters (20, 50, 100 ft).
<b>Pipe sizes</b>	UTT10-050S and UTT10-050H: 50 mm (2") and larger UTT10-050L: 600 mm (24") and larger. UTT10-015S to UTT10-040S: (Small pipe) 15 mm to 40 mm (½" to 1½") (ASME pipe, copper tube, tube).
<b>Environment</b>	IP 67.
<b>Pipe surface temperature</b>	UTT10-050S, UTT10-050L and UTT10-015S to UTT10-040S: -40°C to +90°C (-40°F to +194°F). UTT10-050H: -40°C to +177°C (-40°F to +350°F).
<b>Housing material</b>	UTT10-050S, UTT10-050L and UTT10-015S to UTT10-040S: CPVC, Ultem®, and nylon cord grip, PVC cable jacket. UTT10-050H: PTFE, Vespel®, and nickel-plated brass cord grip, PFA cable jacket.
<b>Approvals</b>	Standard: None. Optional: UTT10-050S only: Class I Division 1, Groups C & D Intrinsically Safe Ex ia; CSA C22.2 No. 142 & 157; UL 913 & 916 Requires intrinsically safe barrier

## 9.1.3 Software Utilities

<b>USP</b>	Utilized for configuration, calibration and troubleshooting. Compatible with Windows 7, Windows XP, Windows Vista®.
------------	--

## 9.1.4 Transmitter

<b>Power requirements</b>	<p>ac: 95-264 Vac 47-63 Hz at 17 VA max. 20-26 Vac 47-63 Hz at 17 VA max.</p> <p>dc: 10-28 Vdc at 5.0 W</p> <p>Protection: Reverse polarity and transient suppression</p> <p>ac: Field replaceable fuse</p> <p>dc: Auto resettable fuse</p>
<b>Installation compliance</b>	<p>General Safety (all models): UL 61010-1, CSA C22.2 No. 61010-1; (power options A and D only) EN 61010-1</p> <p>Hazardous Location (power supply options A and D only): Class I, Division 2, Groups C, D, T4: Class II, Division 2, Groups F, G, T4</p> <p>Class III, Division 2 for US/CAN; Standards: UL 1604, CSA 22.2 No. 213, ANSI/ISA 12.12.01 (2013)</p> <p>Compliant with directives 2004/108/EC and 2006/95/EC on meter systems with integral flow transducers, transducers constructed with twinaxial cable (all transducers with cables 30 m [100 ft] and shorter, or remote transducers with conduit)</p>
<b>Display</b>	<p>2 line LCD, LED backlight</p> <p>Top Row: 7 segment, 18 mm (0.7") high, numeric</p> <p>Bottom Row: 14 segment, 9 mm (0.35") high alpha-numeric</p> <p>Flowrate Indication: 8 digit positive, 7 digit negative max.; auto decimal, lead zero blanking</p> <p>Flow totalizer: 8 digit positive, 7 digit negative. Reset via software, keypad, contact closure</p>
<b>Engineering units</b>	User configured
<b>Rate</b>	Gal, Litres, million gal, ft <sup>3</sup> , m <sup>3</sup> , acre-ft, oil barrels (42 gal), liquor barrels (31.5 gal), ft, m, lb, kg
<b>Time</b>	Additional units for Energy version BTU, MBTU, MMBTU, Ton Seconds, minutes, hours, days
<b>Totalizer</b>	Gal, Litres, million gal, ft <sup>3</sup> , m <sup>3</sup> , acre-ft, oil barrels (42 gal), liquor barrels (31.5 gal), lb, k.
<b>Mode</b>	Additional units for Energy version BTU, MBTU, MMBTU, Ton Forward, reverse, net, batch
<b>4-20 mA</b>	12-bit resolution, internal power (current source). Can span negative to positive flow/energy rates.
<b>USB</b>	2.0 for connection of a PC. (Requires USB A/B interface cable)
<b>10/100 Base-T</b>	RJ45 communications via Modbus TCP/IP, EtherNet/IP and BACnet@/IP.
<b>RS485</b>	Modbus RTU command set or BACnet MSTP; Baud rates 9600, 14400, 19200, 38400, 56000, 57600, 76800

## 9.1.4 Transmitter (continued)

Input/output [UTM10-S transmitter]	Rate Pulse: Open collector, 0 to 1000 Hz maximum; 12 bit resolution, 100 mA max. Can span negative to positive rates. Square-wave or simulated turbine output.
	Open collector, 10 - 28 Vdc, 100 mA max., configure as rate alarm, signal strength alarm or totalizer pulse (100 ms pulse width up to 1 Hz max.) Alarm Outputs (2): Energy model: Total pulse: Opto isolated open collector transistor 2 - 28 Vdc, 100 mA max., 30 ms pulse width up to 16 Hz, 12-bit resolution, can span negative to positive rates; square-wave or turbine meter simulation outputs. Cannot be used with Ethernet option.
	Input: Reset totalizer when input is connected to signal ground
Ambient conditions	-40°C to +55°C (-40°F to +131°F) for line AC power with Ethernet option; -40°C to +65°C (-40°F to +149°F) for all others
Enclosure	Type: IP65 (Type 4). Construction: Powder-coated aluminum, polycarbonate, stainless steel, polyurethane
Size W x H x D	152 x 12 x 56 mm (6" x 4.4" x 2.2")
Transmitter mounting	Type: Wall: Nickel-plated steel mounting brackets Integral transducer: Clamped around pipe Conduit holes: 2 holes x 1/2" NPT Female 1 hole x 3/4" NPT Female
Response time (Flow)	0.3 to 30 seconds, user configured, for 10% to 90% step change in flow
Security	Keypad lockout, user selected 4 digit password code

## 9.2 Menu Maps

### 9.2.1 Basic Menu

<b>UNITS</b> Programming Units English Metric	<b>PIPE W/T</b> Pipe Wall Thickness English (Inches) Metric (mm)	<b>LINER MA</b> Liner Material Eborite Mortar HDPE LDPE Polypropylene Polystyrene Rubber Tar Epoxy Teflon PFA Other	<b>FLUID SS</b> Fluid Sound Speed English (FPS) Metric (MPS)	<b>RATE INT</b> Rate Interval Sec Min Hour Day	<b>MIN RATE</b> Minimum Flow Rate Numeric Entry
<b>ADDRESS</b> Multi-Port Device Address Numeric Entry (1...126)	<b>PIPE MAT</b> Pipe Material Acrylic Aluminum Brass (Naval) Carbon Steel Cast Iron Copper Ductile Iron Fiberglass-Epoxy Glass Pyrex Nylon HD Polyethylene LD Polyethylene Polypropylene PVC CPVC PVDF	<b>LINER SS</b> Liner Sound Speed English (FPS) Metric (MPS)	<b>FLUID VI</b> Fluid Viscosity CPS	<b>Hour</b> <b>Day</b>	<b>MAX RATE</b> Maximum Flow Rate Numeric Entry
<b>RAUD</b> Bandwidth/Address 9600 14400 19200 38400 56000 57600 76800	<b>BACNET ID</b> BACnet Device ID Value 0...4194303	<b>LINER SPAC</b> Liner Spacing English (Inches) Metric (mm) <b>Note:</b> This value is calculated by firmware.	<b>SP GARTY</b> Specific Gravity Numeric Entry	<b>SP HEAT</b> Normal Heat Capacity Numeric Entry	<b>FL C-OFF</b> Low Flow Cutoff Numeric Entry
<b>XDCR MNT</b> Transducer Mounting V W Z	<b>XDCR HZ</b> Transducer Frequency 1 MHz 2 MHz 500 kHz	<b>LINER R</b> Liner Roughness Numeric Entry	<b>SP GRTY</b> Specific Gravity Numeric Entry	<b>TOTL UNT</b> Total Units Gallons Liters Mgal Cubic Ft Cubic M Acre Ft Oil Barr (42 Gall) Lq Barr (31.5 Gall) Feet Meters	<b>DAMP PER</b> Damping Percentage Numeric Entry
<b>PIPE OD</b> Pipe Outside Diameter English (Inches) Metric (mm)	<b>FLOW DIR</b> Flow Direction Forward Reverse	<b>FL TYPE</b> Fluid Type Water Tap Sewage Acetone Alcohol Ammonia Benzene Brine Ethanol Ethylene Glycol Gasoline Glycerin Isopropyl Alcohol Kerosene Methanol Oil Hydraulic (petro-base) Oil Lubricating Oil Motor (SAE20/30) Water Distilled Water Sea Other	<b>RATE UNT</b> Rate Units Gallons Liters Mgal Cubic Ft Cubic M Acre Ft Oil Barr (42 Gall) Lq Barr (31.5 Gall) Feet Meters LB KG	<b>TOTL E</b> Totalizer Equipment E1 (1:0) E1 (X1) E1 (X10) E2 (X100) E3 (X1,000) E4 (X10,000) E5 (X100,000) E6 (X1,000,000)	
<b>PIPE OD</b> Pipe Outside Diameter English (Inches) Metric (mm)	<b>PIPER</b> Relative Roughness Numeric Entry	<b>LINER T</b> Liner Thickness English (Inches) Metric (mm)	<b>SP GRTY</b> Specific Gravity Numeric Entry	<b>FL C-OFF</b> Low Flow Cutoff Numeric Entry	<b>DAMP PER</b> Damping Percentage Numeric Entry

<sup>1</sup> The heat flow measurements only appear when RTD1 is chosen in the Output 2 menu.



## 9.2.2 Channel 1 Menu

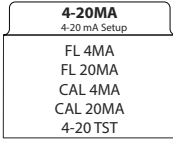

## 9.2.3 Channel 2 Menu

- The Channel 2 menu allows the configuration of meter-specific I/O parameters.
- RTD values are specific to a particular RTD.
- The menu structure and programming are identical for both Control 1 and Control 2, but the choice of function for a specific control output is independent of the other.

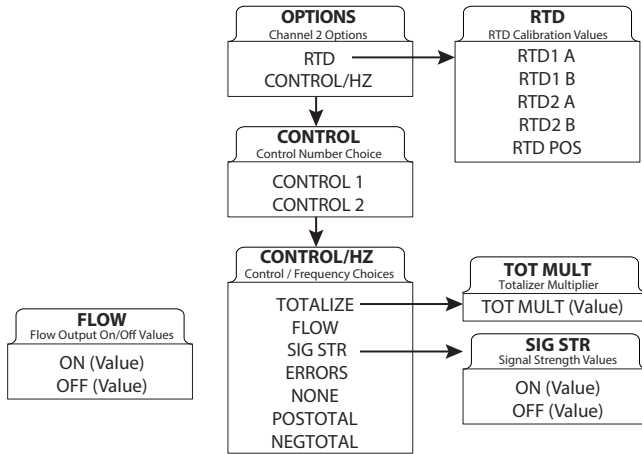

## 9.2.4 Sensor Menu

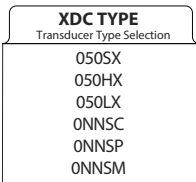

## 9.2.5 Security Menu

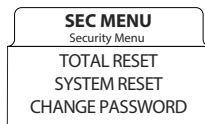

## 9.2.6 Service Menu

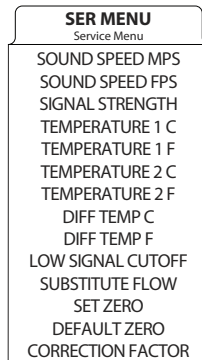

## 9.2.7 Display Menu

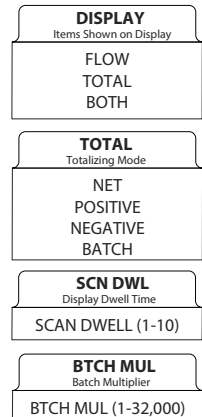

## 9.3 Communications protocols

### 9.3.1 UTM10 MODBUS

#### Modbus RTU

Address: Meter Address / Modbus Address

Baud Rate: Baud Rate Selection (9600, 14400, 19200, 38400, 56000, 57600, 76800)

BACnet ID: Not Used (value does not affect Modbus in any way)

**Table 14 Available data formats**

	Bits	Bytes	Modbus Registers
Long integer	32	4	2
Single precision IEEE754	32	4	2
Double precision IEEE754	64	8	4

### 9.3.2 Modbus register / word ordering

Each Modbus Holding Register represents a 16-bit integer value (2 bytes). The official Modbus standard defines Modbus as a 'big-endian' protocol where the most significant byte of a 16-bit value is sent before the least significant byte. For example, the 16-bit hex value of '1234' is transferred as '12' '34'.

Beyond 16-bit values, the protocol itself does not specify how 32-bit (or larger) numbers that span over multiple registers should be handled. It is very common to transfer 32-bit values as pairs of two consecutive 16-bit registers in little-endian word order. For example, the 32-bit hex value of '12345678' is transferred as '56' '78' '12' '34'. Notice the Register Bytes are still sent in big-endian order per the Modbus protocol, but the Registers are sent in little-endian order.

Other manufacturers, store and transfer the Modbus Registers in big-endian word order. For example, the 32-bit hex value of '12345678' is transferred as '12' '34' '56' '78'. It doesn't matter which order the words are sent, as long as the receiving device knows which way to expect it. Since it's a common problem between devices regarding word order, many Modbus master devices have a configuration setting for interpreting data (over multiple registers) as 'little-endian' or 'big-endian' word order. This is also referred to as swapped or word swapped values and allows the master device to work with slave devices from different manufacturers.

If, however, the endianness is not a configurable option within the Modbus master device, it's important to make sure it matches the slave endianness for proper data interpretation. The UTM10 actually provides two Modbus Register maps to accommodate both formats. This is useful in applications where the Modbus Master cannot be configured for endianness.

Communication settings	
<b>Baud rate</b>	<selectable>
<b>Parity</b>	None
<b>Data bits</b>	8
<b>Stop bits</b>	1
<b>Handshaking</b>	None

**Table 15 UTM10 Modbus register map for 'Little-endian' word order master devices**

**For reference:** If the UTM10 Net Totalizer = 12345678 hex

Register 40102 would contain 5678 hex (word low)

Register 40103 would contain 1234 hex (word high)

Data component name	MODBUS registers			Available units
	Long integer format	Floating point		
		Single precision format	Double Precision format	
Signal strength	40100 - 40101	40200 - 40201	40300 - 40303	
Flowrate	40102 - 40103	40202 - 40203	40304 - 40307	Gallons, Litres, MGallons, Cubic Feet, Cubic Metres, Acre Feet, Oil Barrel, Liquid Barrel, Feet, Metres, Lb, Kg, BTU, MBTU, MMBTU, TON Per Second, Minute, Hour, Day
Net totalizer	40104 - 40105	40204 - 40205	40308 - 40311	
Positive totalizer	40106 - 40107	40206 - 40207	40312 - 40315	
Negative totalizer	40108 - 40109	40208 - 40209	40316 - 40319	
Temperature 1	40110 - 40111	40210 - 40211	40320 - 40323	°C
Temperature 2	40112 - 40113	40212 - 40213	40324 - 40327	°C

**Table 16 UTM10 Modbus register map for 'Big-endian' word order master devices**

**For reference:** If the UTM10 Net Totalizer = 12345678 hex

Register 40602 would contain 1234 hex (word high)

Register 40603 would contain 5678 hex (word low)

Data component name	MODBUS registers			Available units
	Long integer format	Floating point		
		Single precision format	Double Precision format	
Signal strength	40600 - 40601	40700 - 40701	40800 - 40803	
Flowrate	40602 - 40603	40702 - 40703	40804 - 40807	Gallons, Litres, MGallons, Cubic Feet, Cubic Metres, Acre Feet, Oil Barrel, Liquid Barrel, Feet, Metres, Lb, Kg, BTU, MBTU, MMBTU, TON Per Second, Minute, Hour, Day
Net totalizer	40604 - 40605	40704 - 40705	40808 - 40811	
Positive totalizer	40606 - 40607	40706 - 40707	40812 - 40815	
Negative totalizer	40608 - 40609	40708 - 40709	40816 - 40819	
Temperature 1	40610 - 40611	40710 - 40711	40820 - 40823	°C
Temperature 2	40612 - 40613	40712 - 40713	40824 - 40827	°C

**Table 17 Modbus coil map**

Modbus coil description	Modbus coil	Notes
Reset totalizers	1	Forcing this coil on will reset all totalizers. After reset, the coil automatically returns to the off state.

**Table 18 UTM10 BACnet® object mappings**

Object description	BACnet object (access point)	Notes	Available units
Signal strength	AI1	Analog input 1	
Flowrate (Flow model) Energy rate (BTU model)		Analog input 2	Gallons, Litres, MGallons, Cubic Feet, Cubic Metres,
Net totalizer	AI3	Analog input 3	Acre Feet, Oil
Positive totalizer	AI4	Analog input 4	Barrel, Liquid Barrel,
Negative totalizer	AI5	Analog input 5	Feet, Metres, Lb, Kg, BTU, MBTU, MMBTU, TON Per Second, Minute, Hour, Day
Temperature 1	AI6	Analog input 6	°C
Temperature 2	AI7	Analog input 7	°C
Reset totalizers	BO1	Binary output 1 Writing an (1) active state to this object will reset all totalizers. The Object will then automatically return to the (0) inactive state.	

### 9.3.3 Network settings:

IP address, IP subnet, IP gateway, and Device Description are configured through the web interface. IP address and subnet defaults to 192.168.0.100 and 255.255.255.0. Connection to the web interface requires an Ethernet crossover cable, power to the flow meter, and a PC with a web browser. Typing http://192.168.0.100 in the address bar will allow connection to the flow meter's web interface for editing.

**Note:** Changing the IP address will require use of the new number when trying to access the web page. Each meter must be setup with a unique IP address when trying to network multiple units.

### UTM10 flow meter

**Ultrasonic flowmeter**  
DEVICE NAME

---

**Device Configuration**  
BACnet Device ID: 100  
[Edit](#)

---

**Location**  
Enter location information here  
[Edit](#)

---

**Network Settings**  
IP Address: 192.168.0.100  
Subnet Mask: 255.255.255.0  
Gateway IP Address: 0.0.0.0  
[Edit](#)

---

**Network Status**  
MAC Address: 00:40:9D:00:00:00  
Software Revision: 1.11  
Link Duplex: FULL  
Link Speed: 100 MBPS

---

**Passwords**  
User Name   Access Level

**Viewer**   Access to Device Values

**User**   Access to Device Values and  
Resetting Totalizers

**Admin**   Access to Device Values,  
Resetting Totalizers, and  
Configuration

[Edit](#)

[Back to Main Page](#)

### 9.3.4 Diagnostics web page

The Diagnostics web page refreshes itself every 5 seconds and provides real time data from the flow meter.

### Diagnostics

Main page

Device values	
<b>Signal strength</b>	22.8
<b>Flowrate</b>	100.4
<b>Net totalizer</b>	1659.1
<b>Positive totalizer</b>	1659.1
<b>Negative totalizer</b>	0.0
<b>Temp 1</b>	26.5
<b>Temp 2</b>	48.7

This page will automatically refresh every 5 seconds

[Reset Totalizers](#)

Main page

### 9.3.5 BACnet® Object Support

Nine BACnet standard objects are supported, a Device object (DEx), a Binary Output object (BO1), and seven Analog Input objects (AI1 through AI7). The BACnet/IP UDP port defaults to 0xBAC0. The Object Identifier (BACnet Device ID) and Location can both be modified through the web page interface.

**Table 19 BACnet® standard objects**

<b>DEx</b>	<b>Object_Identifier</b>	Defaults to DEx Can modify 'x' through web page (1-9999)	W
	<b>Object_Name</b>	Up to 32 characters	W
	<b>Object_Type</b>	DEVICE (8)	R
	<b>System_Status</b>	OPERATIONAL or NON-OPERATIONAL	R
	<b>Vendor_Name</b>		R
	<b>Vendor_Identifier</b>	306	R
	<b>Model_Name</b>	'UTM10'	R
	<b>Application_Software_Version</b>	'1.07'	R
	<b>Location</b>	'Sample Device Location' Up to 64 characters - can modify through web page	W
	<b>Protocol_Version</b>	1	R
	<b>Protocol_Revision</b>	2	R
	<b>Protocol_Services_Supported</b>	{ readProperty, writeProperty, readPropertyMultiple, writePropertyMultiple, deviceCommunicationControl, who-Has, who-Is }	R
	<b>Protocol_Object_Types_Supported</b>	{ AnalogInput, BinaryOutput, Device }	R
	<b>Object_List</b>	DEx, AI1, AI2, AI3, AI4, AI5, AI6, AI7, BO1	R
	<b>Max_APDU_Length_Accepted</b>	1476	R
	<b>Segmentation_Supported</b>	3 – NONE	R
	<b>APDU_Timeout</b>	3000 default	R
	<b>Number_Of_APDU_Retries</b>	1 default	R
	<b>Device_Address_Binding</b>	always empty	R
	<b>Database_Revision</b>	0	R

### 9.3.6 BACnet® protocol implementation conformance statement

**Date:** 3-February 2011  
**Vendor name:**  
**Product name:** UTM10  
**Product model number:** UTM10n-Ennn  
**Applications software version:** 1.07  
**Firmware revision:** N/A  
**BACnet protocol version:** 1  
**BACnet protocol revision:** 2  
**Product description:** Clamp-on ultrasonic flow and energy flow meters for liquids  
  
**BACnet standardized device profile (Annex L):** BACnet Application Specific Controller (B-ASC)  
**BACnet interoperability building blocks supported (Annex K):** DS-RP-B, DS-WP-B, DS-WPM-B, DM-DDB-B, DM-DOB-B and DM-DCC-B  
**BSegmentation capability:** None

#### Standard object types supported:

	1 - Device object	7 - Analog input	1 - Binary output
<b>Dynamically create?</b>	No	No	No
<b>Dynamically delete?</b>	No	No	No
<b>Optional properties supported</b>	Location	None	None
<b>Writable non-required properties</b>	Location	None	None
<b>Proprietary properties</b>		Double_Value (1000)	None
<b>Property range limits</b>	None special	None special	None special

**Data link layer options:** BACnet/IP (Annex J)  
**Device address binding:** No  
**Networking options:** n/a  
**Character sets supported:** ANSI X3.4  
**Non-BACnet networks that the gateway supports:** n/a

## 9.4 Heating and cooling measurement

The UTM10-E energy flow meter is designed to measure the rate and quantity of heat delivered to a given building, area or heat exchanger. The instrument measures the volumetric flowrate of the heat exchanger liquid (water, water / glycol mixture, brine, etc.), the temperature at the inlet pipe and the temperature at the outlet pipe. Heat delivery is calculated by the following equation:

$$\text{Rate of heat delivery} = Q \cdot (T_{in} - T_{out}) \cdot C_p$$

Where:

- Q = volumetric flow rate
- T<sub>in</sub> = temperature at the inlet
- T<sub>out</sub> = temperature at the outlet
- C<sub>p</sub> = specific heat of the liquid

The RTD temperature measurement circuit in the UTM10 flow meter measures the differential temperature of two 1000 Ohm, three-wire platinum RTDs. The three-wire configuration allows the temperature sensors to be located several hundred feet away from the flow meter without influencing system accuracy or stability.

Platinum RTD	
Type	1 000 Ohm
Accuracy	±0.3°C (±0.54°F), 0.0385 curve
Temperature response	Positive temperature coefficient

The UTM10-E energy flow meter allows integration of two 1000 Ohm platinum RTDs with the UTM10 flow meter, effectively providing an instrument for measuring energy delivered in liquid cooling and heating systems. If RTDs were ordered with the UTM10 flow meter, they have been factory calibrated and are shipped connected to the module as they were calibrated.

Field replacement of RTDs is possible through the use of the keypad or the software utility. If the RTDs were ordered from the manufacturer of the UTM10, they will come with calibration values that need to be loaded into the UTM10.

New, non-calibrated RTDs will need to be field calibrated using an ice bath and boiling water to derive calibration values. This procedure is outlined below.

### 9.4.1 In field calibration of RTD temperature sensors

Replacement RTD temperature sensors used in heat flow measurements must be calibrated in the field to ensure proper operation. Failure to calibrate the RTDs to the specific BTU inputs will result in inaccurate heat flow measurements.

#### Equipment required:

- Ice bath
- Boiling water bath
- Laboratory grade thermometer accurate to ±0.1°C (±0.18°F)
- Software utility

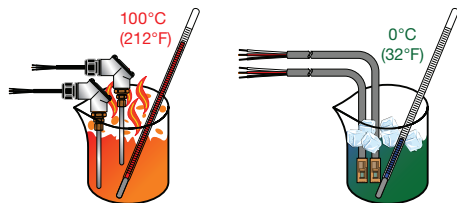

Fig. 52 RTD temperature sensors



### 9.4.2 Replacing or re-calibrating RTDs

This procedure works with pairs of surface mount RTDs or pairs of insertion RTDs supplied by the manufacturer of the UTM10 flow meter.

- 1) Connect the RTDs.
- 2) Establish communications with the flow meter using the software utility.
- 3) Click on the 'Configuration' tab in the menu bar and then select the 'Output' tab.

The screen should now look something like the following:

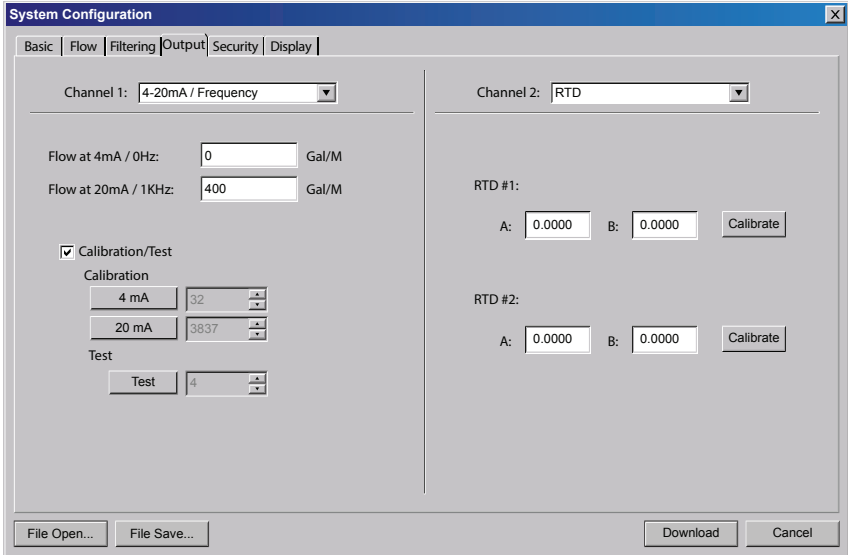
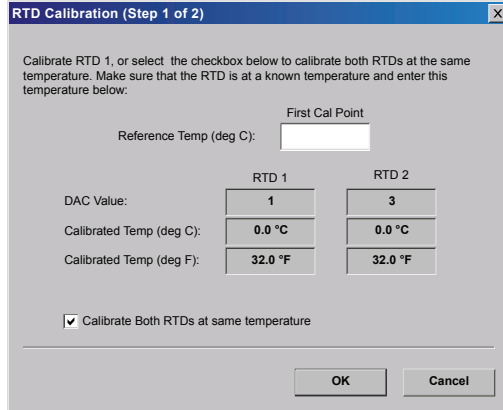

**Fig. 53 UTM10 output configuration screen**

- 4) If 'RTD' is not selected in the Channel 2 drop-down list, select it now.
- 5) Insert both RTD temperature sensors and the laboratory grade thermometer into either the ice bath or the boiling water bath and allow about 20 minutes for the sensors to come up to the same temperature.

**Note:** An ice bath and boiling water bath are used in these examples because their temperatures are easy to maintain and provide known temperature reference points. Other temperature references can be used as long as there is a minimum delta T of 40°C (104°F) between the two references.

- 6) Click on the 'Calibrate' button and the following screen should now be visible. Make sure that the 'Calibrate Both RTDs at same temperature' box is checked and then enter the temperature to the nearest 0.1°C (0.18°F) in the box labeled 'Reference Temp (deg C)'.
  - 7) Press 'Next'.
- The procedure for Step 2 of 2 is similar to Step 1 except the second water bath is used.



**Fig. 54 RTD calibration (Step 1 of 2)**

- 8) Insert both RTD temperature sensors and the laboratory grade thermometer into the second water bath and allow about 20 minutes for the sensors to come up to the same temperature. Make sure that the 'Both RTDs at same temperature' box is checked and then enter the temperature to the nearest 0.1°C (0.18°F) in the box labeled 'Temp (deg C)'.
- 9) Press 'OK'.
- 10) Press 'Download' on the 'System configuration' screen to save the calibration values to the flow meter. After the download is complete, turn the power off and then on again to the flow meter to make the newly downloaded values take effect.

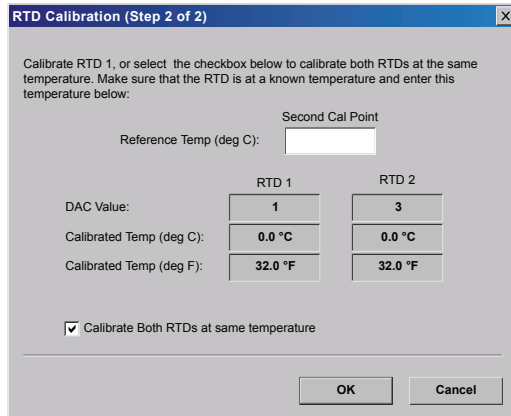

**Fig. 55 RTD calibration (Step 2 of 2)**

If the calibration points are not separated by at least 40°C (104°F) or if either one or both of the RTDs are open, the following error message will be displayed:

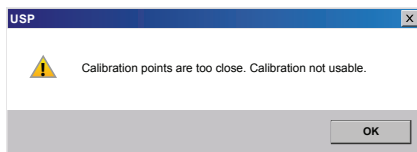

Check the RTDs resistance values with an ohmmeter to make sure they are not 'open' or 'shorted'. See *Table 21 on page 104* for typical RTD resistance values. Next check to ensure that incorrect 'Cal Point' values were not entered inadvertently.

**Table 20 Heat capacity of water**

Temp. °C	Heat capacity of water (J/g°C)									
	0	1	2	3	4	5	6	7	8	9
0	4.2174	4.2138	4.2104	4.2074	4.2045	4.2019	4.1996	4.1974	4.1954	4.1936
10	4.1919	4.1904	4.1890	4.1877	4.1866	4.1855	4.1846	4.1837	4.1829	4.1822
20	4.1816	4.0310	4.1805	4.1801	4.1797	4.1793	4.1790	4.1787	4.1785	4.1783
30	4.1782	4.1781	4.1780	4.1780	4.1779	4.1779	4.1780	4.1780	4.1781	4.1782
40	4.1783	4.1784	4.1786	4.1788	4.1789	4.1792	4.1794	4.1796	4.1799	4.1801
50	4.1804	4.0307	4.1811	4.1814	4.1817	4.1821	4.1825	4.1829	4.1833	4.1837
60	4.1841	4.1846	4.1850	4.1855	4.1860	4.1865	4.1871	4.1876	4.1882	4.1887
70	4.1893	4.1899	4.1905	4.1912	4.1918	4.1925	4.1932	4.1939	4.1946	4.1954
80	4.1961	4.1969	4.1977	4.1985	4.1994	4.2002	4.2011	4.2020	4.2029	4.2039
90	4.2048	4.2058	4.2068	4.2078	4.2089	4.2100	4.2111	4.2122	4.2133	4.2145

**Table 21 Standard RTD resistance values**

Temperature		Standard RTD (Ohms)	
°C	°F	100 Ohm	1000 Ohm
-50	-58	80.306	803.06
-40	-40	84.271	842.71
-30	-22	88.222	882.22
-20	-4	92.160	921.60
-10	14	96.086	960.86
0	32	100.000	1000.00
10	50	103.903	1039.03
20	68	107.794	1077.94
25	77	109.735	1097.35
30	86	111.673	1116.73
40	104	115.541	1155.41
50	122	119.397	1193.97
60	140	123.242	1232.42
70	158	127.075	1270.75
80	176	130.897	1308.97
90	194	134.707	1347.07
100	212	138.506	1385.06
110	230	142.293	1422.93
120	248	146.068	1460.68
130	266	149.832	1498.32

## 9.5 UTM10 error codes

**Table 22 UTM10 error codes**

Revised 5-25-2009		
Code number	Description	Correction
<b>Warnings</b>		
0001	Serial number not present	Hardware serial number has become inoperative – system performance will not be influenced.
0010	Signal strength is below Signal strength cut-off entry	Low signal strength is typically caused by one of the following: » Empty pipe » Improper programming/incorrect values » Improper transducer spacing » Non-homogeneous pipe wall
0011	Measured speed of sound in the liquid is greater than $\pm 10\%$ different than the value entered during flow meter set-up	Verify that the correct liquid was selected in the BASIC menu. Verify that pipe size parameters are correct.
<b>Class C errors</b>		
1001	System tables have changed	Initiate a flow meter RESET by cycling power or by selecting SYSTEM RESET in the SEC MENU.
1002	System configuration has changed	Initiate a flow meter RESET by cycling power or by selecting SYSTEM RESET in the SEC MENU.
<b>Class B errors</b>		
3001	Invalid hardware configuration	Upload corrected file.
3002	Invalid system configuration	Upload corrected file.
3003	Invalid strategy file	Upload corrected file.
3004	Invalid calibration data	Re-calibrate the system.
3005	Invalid speed of sound calibration data	Upload new data.
3006	Bad system tables	Upload new table data.
<b>Class A errors</b>		
4001	Flash memory full	Return unit to factory for evaluation

## 9.6 Product labels

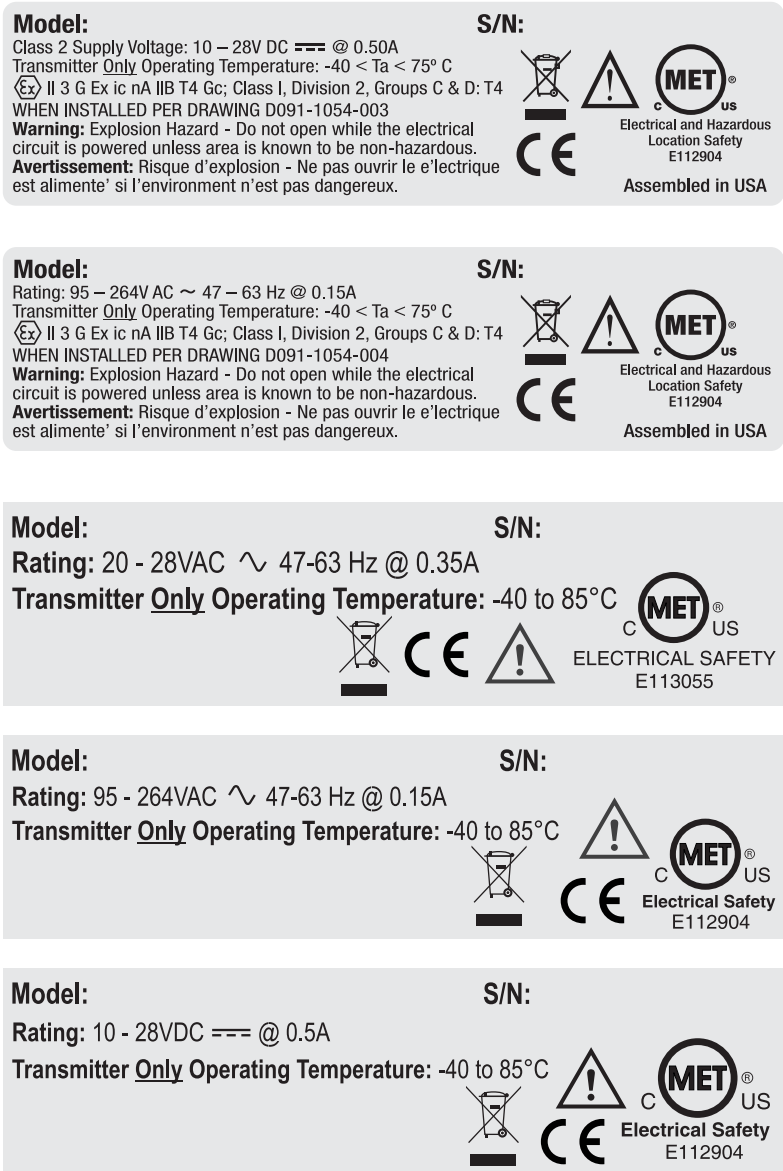

Fig. 56 Product Labels









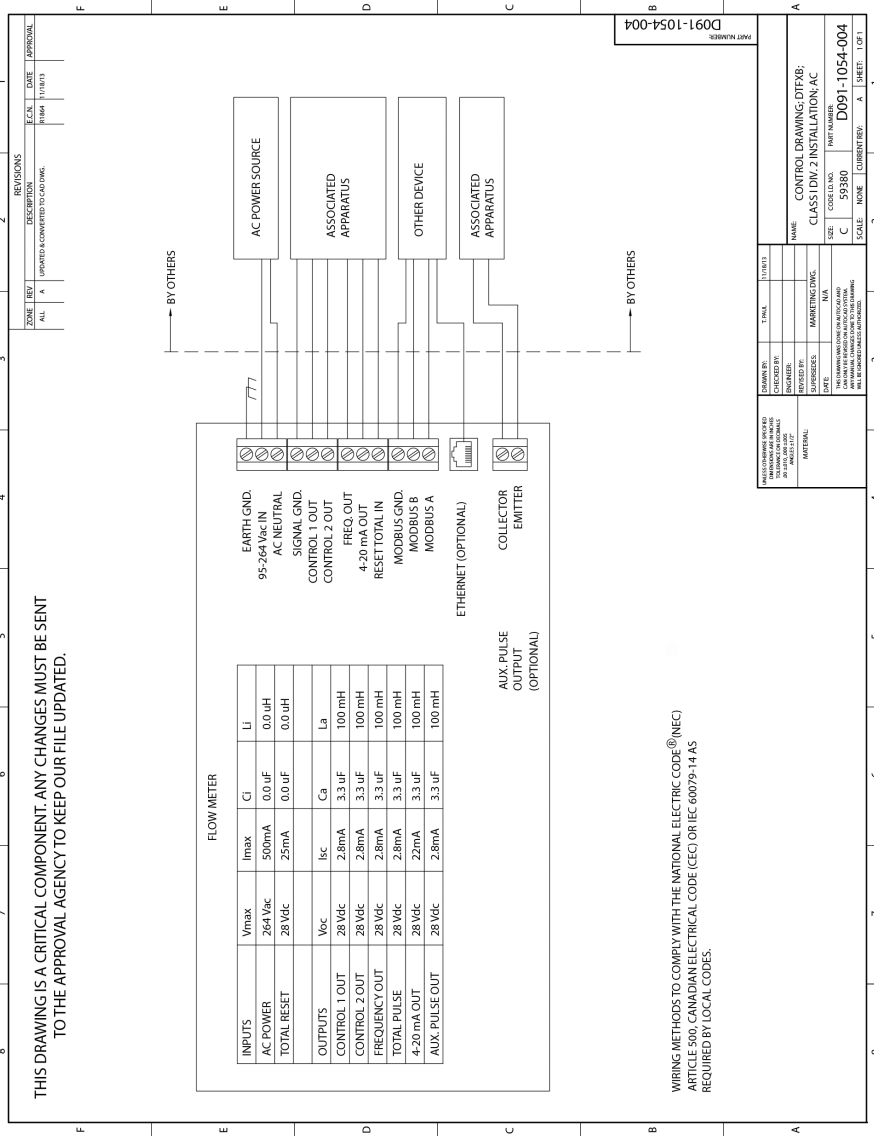

WIRING METHODS TO COMPLY WITH THE NATIONAL ELECTRIC CODE® (NEC) ARTICLE 500, CANADIAN ELECTRICAL CODE (CEC) OR IEC 60079-14 AS REQUIRED BY LOCAL CODES.

**Fig. 60 Control drawing Class 1, Div II dc**

ZONE		REV.	DESCRIPTION	E.C.N.	DATE	APPROVAL
ALL		A	UPDATED & CONVERTED TO CAD FILE.		11/18/13	

EXAMINER:	TITLE:
DESIGNED BY:	
CHECKED BY:	
SUPPRESSED BY:	
DATE:	
<small>THIS DRAWING IS A CRITICAL COMPONENT. ANY CHANGES MUST BE SENT TO THE APPROVAL AGENCY TO KEEP OUR FILE UPDATED.</small>	
<b>CONTROL DRAWING: DTF&amp;B; CLASS 1 DIV. 2 INSTALLATION-AC</b>	
<small>NAME</small> <small>CODE EL. NO.</small> <small>SIZE</small> <small>SCALE</small>	
<b>D091-1054-004</b>	
<small>PART NUMBER</small> <small>SCALE</small> <small>CURRENT REV.</small> <small>SHEET</small>	
<b>D091-1054-004</b>	

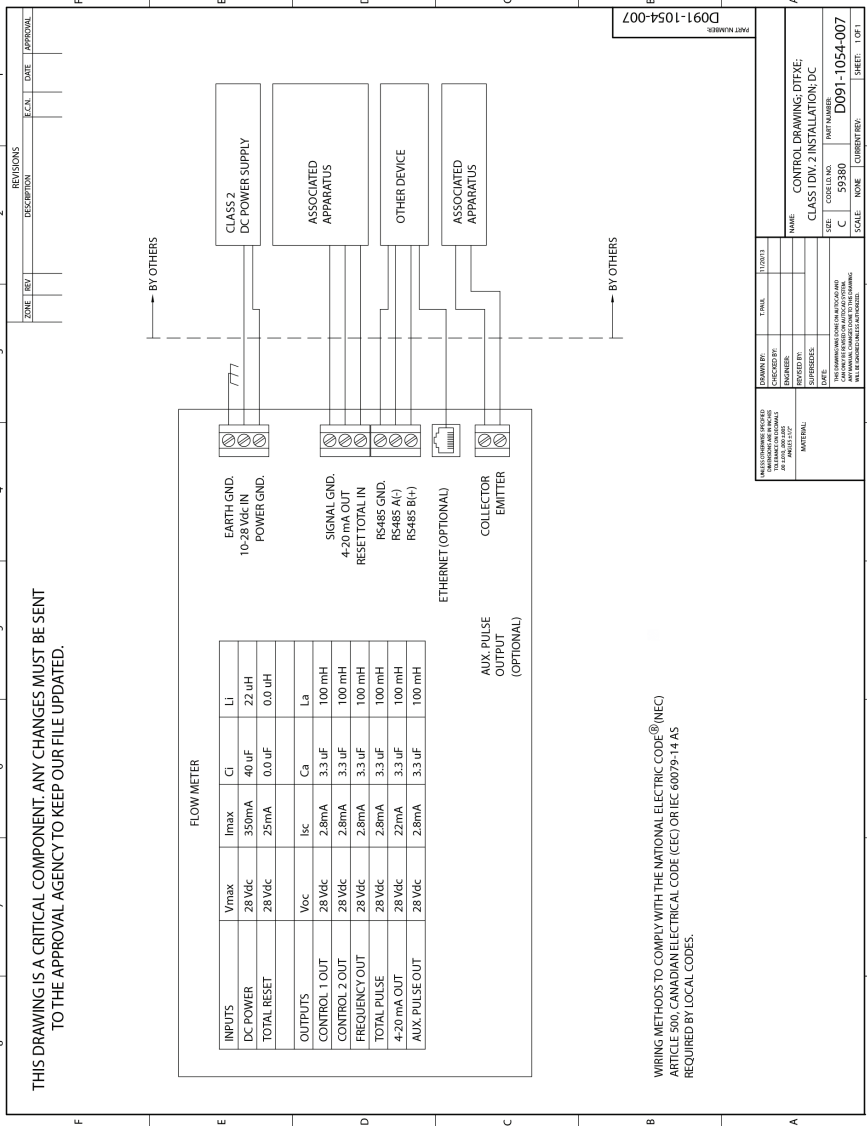
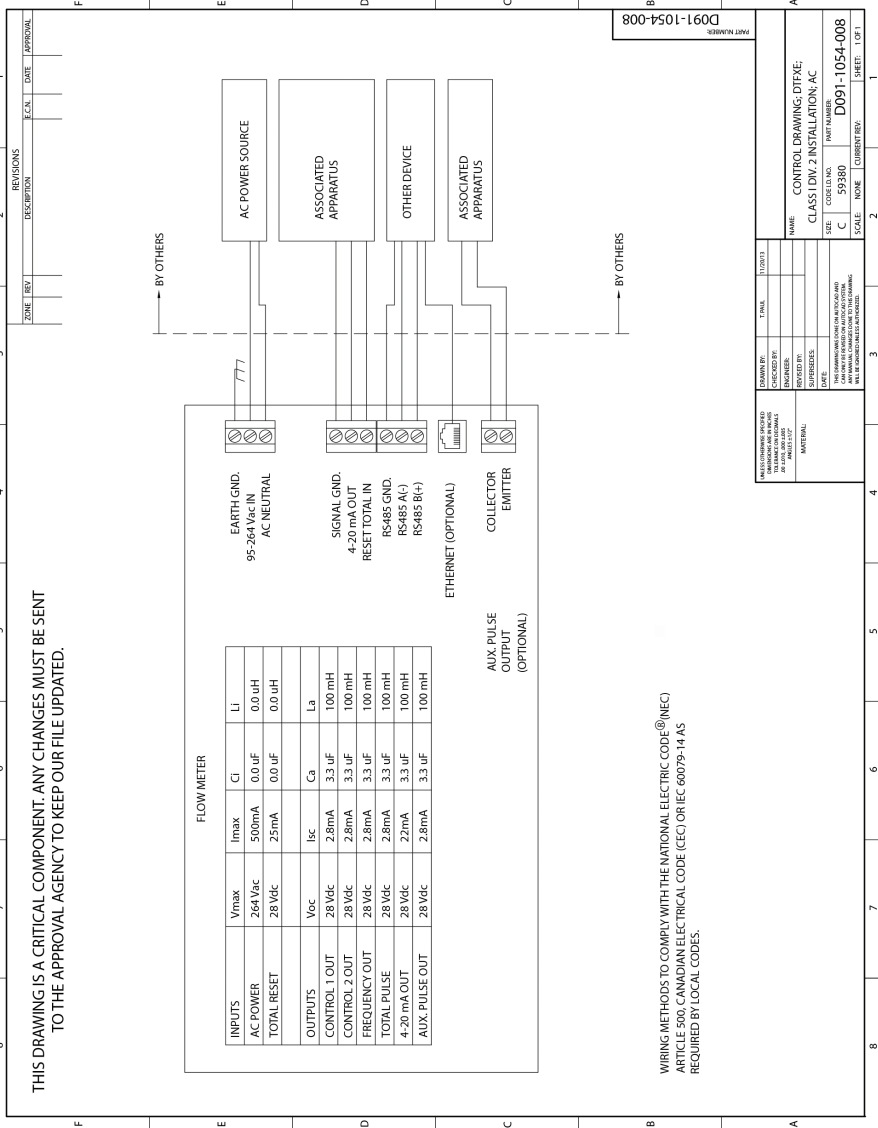
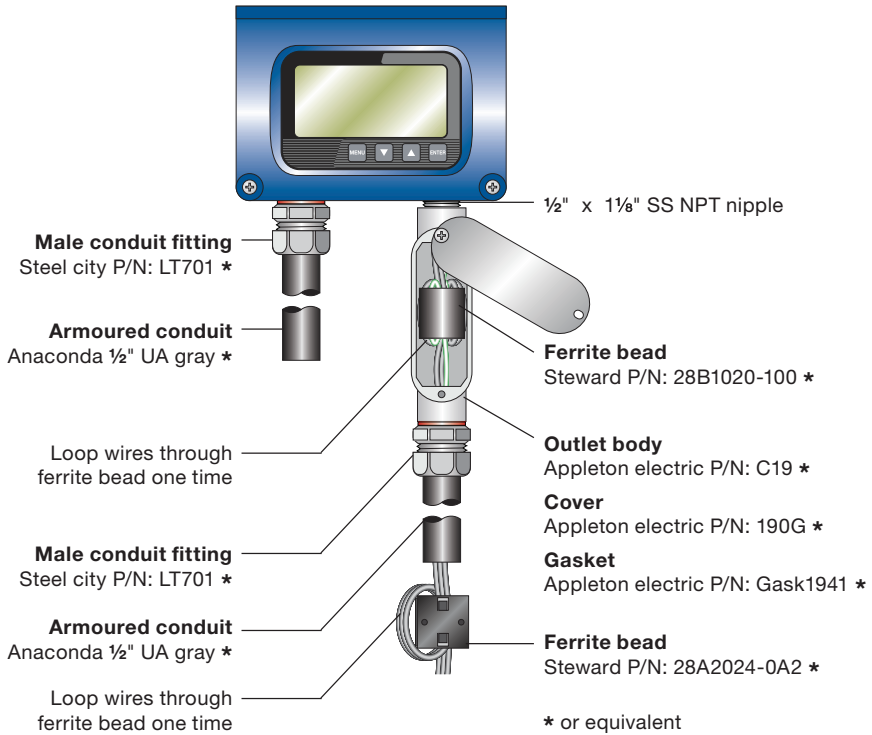

Fig. 61 Control drawing Class 1 Div 2 installation, dc

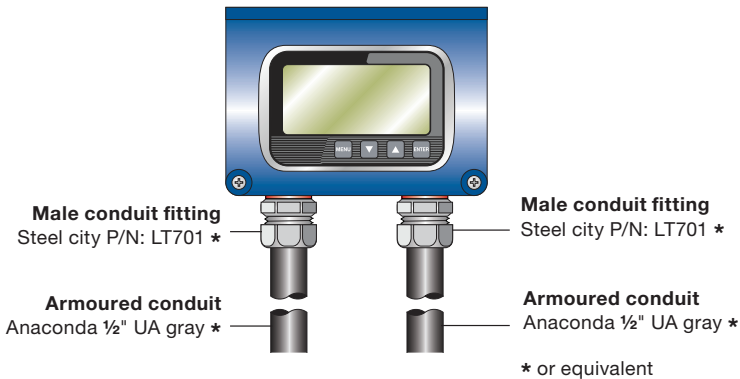

**Fig. 62 Control drawing Class 1 Div 2 installation, ac**

## 9.8 CE compliance drawings



**Fig. 63 CE compliance drawing for ac powered flow meters**



**Fig. 64 CE compliance drawing for dc powered flow meters**

## 9.9 K-factors explained

The K-factor (with regards to flow) is the number of pulses that must be accumulated to equal a particular volume of fluid. You can think of each pulse as representing a small fraction of the totalizing unit.

An example might be a K-factor of 250 (pulses per litre). This means that if you were counting pulses, when the count total reached 250, you would have accumulated 1 litre of liquid. Using the same reasoning each individual pulse represents an accumulation of 1/250 of a litre. This relationship is independent of the time it takes to accumulate the counts.

The frequency aspect of K-factors is a little more confusing because it also involves the flowrate. The same K-factor number, with a time frame added, can be converted into a flowrate. If you accumulated 1000 counts (four litres) in one minute, then your flowrate would be 4 Litres/minute (4 LPM). The output frequency, in Hz, is found simply by dividing the number of counts (1000) by the number of seconds (60) to get the output frequency.

$1000 \div 60 = 16.6666\dots$  Hz. If you were looking at the pulse output on a frequency counter, an output frequency of 16.666...Hz would be equal to 4 Litres/minute (4 LPM). If the frequency counter registered 33.333...Hz ( $2 \times 16.666\dots$ Hz), then the flowrate would 8 Litres/minute (8 LPM).

Finally, if the flowrate is 8 Litres/minute (8 LPM), then the accumulation of 1000 counts would take place in 30 seconds because the flowrate, and hence the speed that the 1000 counts is achieved would be twice as fast.

### 9.9.1 Calculating K-factors for ultrasonic flow meters

Many styles of ultrasonic flow meters are capable of measuring flow in a wide range of pipe sizes. Because the pipe size and volumetric units the flow meter will be used on vary, it is not possible to provide a discrete K-factor. Instead the velocity range of the flow meter is usually provided along with a maximum frequency output.

The most basic K-factor calculation requires that an accurate flowrate and the output frequency associated with that flowrate be known.

#### Example 1:

**Known values are:**

Frequency = 700 Hz

Flowrate = 218.21 Litres/minute 'LPM' (48 gallons/minute 'GPM')

- 1)  $700 \text{ Hz} \times 60 \text{ sec} = 42\,000 \text{ pulses/minute}$
- 2)  $\text{K-factor} = \frac{42\,000 \text{ pulses/minute}}{218.21 \text{ LPM (48 GPM)}} = 192.47 \text{ pulses/litre (875 pulses/gallon)}$

#### Example 2:

**Known values are:**

Full-scale flowrate = 386.42 Litres/minute 'LPM' (85 gallons/minute 'GPM')

Full-scale output frequency = 650 Hz

- 1)  $650 \text{ Hz} \times 60 \text{ sec} = 39\,000 \text{ pulses/minute}$
- 2)  $\text{K-factor} = \frac{39\,000 \text{ pulses/minute}}{386.42 \text{ LPM (85 GPM)}} = 100.93 \text{ pulses/litre (458.82 pulses/gallon)}$

The calculation is a little more complex if velocity is used because you first must convert the velocity into a volumetric flowrate to be able to compute a K-factor.

To convert a velocity into a volumetric flow, the velocity measurement and an accurate measurement of the inside diameter of the pipe must be known. If using Imperial units, 1 US gallon is equal to 231 cubic inches.

### Example 3:

#### Known values are:

Velocity: = 1.31 m / s (4.3 ft / s)

Inside diameter of pipe = 0.0779 m (3.068")

Frequency = 700 Hz

1) Find the cross-sectional area of the pipe:

$$\text{Area} = \pi \times r^2 = \pi \times \left( \frac{0.0779}{2} \right)^2 = 0.00477 \text{m}^2 \quad (7.39 \text{in}^2)$$

2) Find the volumetric flow:

$$V = \text{Velocity} \times \text{Area} = 1.31 \times 0.00477 = 0.00624 \text{ m}^3\text{s}^{-1} \text{ or } (9.679 \text{in}^3 \text{ s}^{-1})$$

3) Find the K-factor:

$$\begin{aligned} \text{K-factor} &= \frac{\text{frequency}}{\text{Volumetric flow}} = && 112179.49 \text{ pulses per m}^3 \\ & && = 112.18 \text{ pulses/litre (423.9 pulses/gallon)} \end{aligned}$$

## 9.10 Table 23 - Fluid properties

Fluid	Specific gravity at 20°C (68°F)	Sound speed		Kinematic viscosity (cSt)	Absolute viscosity (Cp)
		m/s	ft/s		
Acetate, Butyl		1270.2	4163.9		
Acetate, Ethyl	0.901	1085.2	3559.7	0.489	0.441
Acetate, Methyl	0.934	1211.2	3973.1	0.407	0.380
Acetate, Propyl		1280.2	4196.7		
Acetone	0.79	1174.2	3851.7	0.399	0.316
Alcohol	0.79	1207.2	3960.0	1.396	1.101
Alcohol, Butyl	0.83	1270.2	4163.9	3.239	2.688
Alcohol, Ethyl	0.83	1180.2	3868.9	1.396	1.159
Alcohol, Methyl	0.791	1120.2	3672.1	0.695	0.550
Alcohol, Propyl		1170.2	3836.1		
Alcohol, Propyl	0.78	1222.2	4009.2	2.549	1.988
Ammonia	0.77	1729.2	5672.6	0.292	0.225
Aniline	1.02	1639.2	5377.3	3.630	3.710
Benzene	0.88	1306.2	4284.8	0.711	0.625
Benzol, Ethyl	0.867	1338.2	4389.8	0.797	0.691
Bromine	2.93	889.2	2916.7	0.323	0.946
n-Butane	0.60	1085.2	3559.7		
Butyrate, Ethyl		1170.2	3836.1		
Carbon dioxide	1.10	839.2	2752.6	0.137	0.151
Carbon tetrachloride	1.60	926.2	3038.1	0.607	0.968
Chloro-benzene	1.11	1273.2	4176.5	0.722	0.799
Chloroform	1.49	979.2	3211.9	0.550	0.819
Diethyl ether	0.71	985.2	3231.6	0.311	0.222
Diethyl Ketone		1310.2	4295.1		
Diethylene glycol	1.12	1586.2	5203.4		
Ethanol	0.79	1207.2	3960.0	1.390	1.097
Ethyl alcohol	0.79	1207.2	3960.0	1.396	1.101
Ether	0.71	985.2	3231.6	0.311	0.222
Ethyl ether	0.71	985.2	3231.6	0.311	0.222
Ethylene glycol	1.11	1658.2	5439.6	17.208	19.153
Freon R12		774.2	2540.0		
Glycol	1.11	1658.2	5439.6		
Isobutanol	0.81	1212.24	3976.4		
Iso-Butane		1219.80	4002		
Isopentane	0.62	980.24	3215.2	0.340	0.211
Isopropanol	0.79	1170.24	3838.6	2.718	2.134
Isopropyl Alcohol	0.79	1170.24	3838.6	2.718	2.134
Kerosene	0.81	1324.24	4343.8		
Linalool		1400.24	4590.2		
Linseed Oil	0.925 - 0.939	1770.24	5803.3		
Methanol	0.79	1076.24	3530.2	0.695	0.550
Methyl Alcohol	0.79	1076.24	3530.2	0.695	0.550
Methylene Chloride	1.33	1070.24	3510.5	0.310	0.411
Methylethyl Ketone		1210.24	3967.2		



**9.9 Table 23 - Fluid properties (continued)**

Fluid	Specific gravity at 20°C (68°F)	Sound speed		Kinematic viscosity (cSt)	Absolute viscosity (Cp)
		m/s	ft/s		
Motor Oil (SAE 20/30)	0.88 - 0.935	1487.24	4875.4		
Octane	0.70	1172.24	3845.1	0.730	0.513
Oil, Castor	0.97	1477.24	4845.8	0.670	0.649
Oil, Diesel	0.80	1250.24	4101		
Oil (Lubricating X200)		1530.24	5019.9		
Oil (Olive)	0.91	1431.24	4694.9	100.000	91 .200
Oil (Peanut)	0.94	1458.24	4783.5		
Paraffin Oil		1420.24	4655.7		
Pentane	0.626	1020.24	3346.5	0.363	0.227
Petroleum	0.876	1290.24	4229.5		
1-Propanol	0.78	1222.24	4009.2		
Refrigerant 11	1.49	828.30	2717.5		
Refrigerant 12	1.52	774.10	2539.7		
Refrigerant 14	1.75	875.24	2871.5		
Refrigerant 21	1.43	891.24	2923.2		
Refrigerant 22	1.49	893.90	2932.7		
Refrigerant 113	1.56	783.70	2571.2		
Refrigerant 114	1.46	665.30	2182.7		
Refrigerant 115		656.4	2153.5		
Refrigerant C318	1.620	574.4	1883.2		
Toluene	0.870	1328.4	4357.0	0.644	0.558
Transformer Oil		1390.4	4557.4		
Trichlorethylene		1050.4	3442.6		
1,1,1 -Trichloroethane	1.330	985.4	3231.6	0.902	1.200
Turpentine	0.880	1255.4	4117.5	1.400	1.232
Water, distilled	0.996	1498.4	4914.7	1.000	0.996
Water, heavy	1.000	1400.4	4593.0		
Water, sea	1.025	1531.4	5023.0	1.000	1.025
Wood Alcohol	0.791	1076.4	3530.2	0.695	0.550
m-Xylene	0.868	1343.4	4406.2	0.749	0.650
o-Xylene	0.897	1331.5	4368.4	0.903	0.810
p-Xylene		1334.4	4376.8	0.662	

## 9.11 Symbol explanations



**CAUTION:**  
Refer to accompanying documents.

### UTM10 flow meter installation



**WARNING:**  
Explosion hazard - Substitution of components may impair suitability for Class I, Division 2.



**WARNING:**  
Do not connect or disconnect either power or outputs unless the area is known to be non-hazardous.







**IMPORTANT Note:**  
Not following instructions properly may impair safety of equipment and/or personnel.



**IMPORTANT Note:**  
Must be operated by a Class II supply suitable for the location.



**IMPORTANT Note:**  
Do not connect the interface cable between a UTM10 series ultrasonic flow meter and a personal computer unless the area is known to be non-hazardous.

Electrical symbols					
Function	Direct current	Alternating current	Earth (Ground)	Protective ground	Chassis ground
Symbol	 dc	 ac			

## 9.12 Table 24 - ASME pipe data

"Steel, stainless steel, P.V.C. pipe" Standard classes													
NPS in.	OD in.	SCH 5		SCH 10 (Lt wall)		SCH 20		SCH 30		STD		SCH 40	
		ID in.	Wall in.	ID in.	Wall in.	ID in.	Wall in.	ID in.	Wall in.	ID in.	Wall in.	ID in.	Wall in.
1"	1.315	1.185	0.065	1.097	0.109					1.049		1.049	0.133
1.25"	1.660	1.53	0.065	1.442	0.109					1.380		1.380	0.140
1.5"	1.900	1.77	0.065	1.682	0.109					1.610		1.610	0.145
2"	2.375	2.245	0.065	2.157	0.109					2.067		2.067	0.154
2.5"	2.875	2.709	0.083	2.635	0.120					2.469		2.469	0.203
3"	3.500	3.334	0.083	3.260	0.120					3.068		3.068	0.216
3.5"	4.000	3.834	0.083	3.760	0.120					3.548		3.548	0.226
4"	4.500	4.334	0.083	4.260	0.120					4.026	0.237	4.026	0.237
5"	5.563	5.345	0.109	5.295	0.134					5.047	0.258	5.047	0.258
6"	6.625	6.407	0.109	6.357	0.134					6.065	0.280	6.065	0.280
8"	8.625	8.407	0.109	8.329	0.148	8.125	0.250	8.071	0.277	7.981	0.322	7.981	0.322
10"	10.75	10.482	0.134	10.42	0.165	10.25	0.250	10.13	0.310	10.02	0.365	10.02	0.365
12"	12.75	12.42	0.165	12.39	0.180	12.25	0.250	12.09	0.330	12.00	0.375	11.938	0.406
14"	14.00			13.50	0.250	13.37	0.315	13.25	0.375	13.25	0.375	13.124	0.438
16"	16.00			15.50	0.250	15.37	0.315	15.25	0.375	15.25	0.375	15.000	0.500
18"	18.00			17.50	0.250	17.37	0.315	17.12	0.440	17.25	0.375	16.876	0.562
20"	20.00			19.50	0.250	19.25	0.375	19.25	0.375	19.25	0.375	18.814	0.593
24"	24.00			23.50	0.250	23.25	0.375	23.25	0.375	23.25	0.375	22.626	0.687
30"	30.00			29.37	0.315	29.00	0.500	29.00	0.500	29.25	0.375	29.25	0.375
36"	36.00			35.37	0.315	35.00	0.500	35.00	0.500	35.25	0.375	35.25	0.375
42"	42.00									41.25	0.375	41.25	0.375
48"	48.00									47.25	0.375	47.25	0.375

### 9.13 Table 25 - ASME pipe data

"Steel, stainless steel, P.V.C. pipe" Standard classes													
NPS in.	OD in.	SCH 5		SCH 10 (Lt wall)		SCH 20		SCH 30		STD		SCH 40	
		ID in.	Wall in.	ID in.	Wall in.	ID in.	Wall in.	ID in.	Wall in.	ID in.	Wall in.	ID in.	Wall in.
1"	1.315			0.957	0.179	0.957	0.179					0.815	0.250
1.25"	1.660			1.278	0.191	1.278	0.191					1.160	0.250
1.5"	1.900			1.500	0.200	1.500	0.200					1.338	0.281
2"	2.375			1.939	0.218	1.939	0.218					1.687	0.344
2.5"	2.875			2.323	0.276	2.323	0.276					2.125	0.375
3"	3.500			2.900	0.300	2.900	0.300					2.624	0.438
3.5"	4.000			3.364	0.318	3.364	0.318						
4"	4.500			3.826	0.337	3.826	0.337			3.624	0.438	3.438	0.531
5"	5.563			4.813	0.375	4.813	0.375			4.563	0.500	4.313	0.625
6"	6.625			5.761	0.432	5.761	0.432			5.501	0.562	5.187	0.719
8"	8.625	7.813	0.406	7.625	0.500	7.625	0.500	7.437	0.594	7.178	0.719	6.183	1.221
10"	10.75	9.750	0.500	9.75	0.500	9.562	0.594	9.312	0.719	9.062	0.844	8.500	1.125
12"	12.75	11.626	0.562	11.75	0.500	11.37	0.690	11.06	0.845	10.75	1.000	10.12	1.315
14"	14.00	12.814	0.593	13.00	0.500	12.50	0.750	12.31	0.845	11.81	1.095	11.18	1.410
16"	16.00	14.688	0.656	15.00	0.500	14.31	0.845	13.93	1.035	13.56	1.220	12.81	1.595
18"	18.00	16.564	0.718	17.00	0.500	16.12	0.940	15.68	1.160	15.25	1.375	14.43	1.785
20"	20.00	18.376	0.812	19.00	0.500	17.93	1.035	17.43	1.285	17.00	1.500	16.06	1.970
24"	24.00	22.126	0.937	23.00	0.500	21.56	1.220	20.93	1.535	20.93	1.535	19.31	2.345
30"	30.00			29.00	0.500								
36"	36.00			35.00	0.500								
42"	42.00			41.00	0.500								
48"	48.00			47.00	0.500								

## 9.14 Table 26 - Copper tube data

Nominal diameter (in.)	Copper tubing			Copper & brass pipe (in.)	Alum. (in.)	Nominal diameter (in.)	Copper tubing			Copper & brass pipe (in.)	Alum. (in.)			
	Type	K (in.)	L (in.)				M (in.)	Type	K (in.)			L (in.)	M (in.)	
½"	O. D.	0.625	0.625	0.625	0.840		3½"	O. D.	3.625	3.625	3.625	4.000		
	Wall	0.049	0.040	0.028	0.108			Wall	0.120	0.100	0.083	0.250		
	I. D.	0.527	0.545	0.569	0.625			I. D.	3.385	3.425	3.459	3.500		
⅝"	O. D.	0.750	0.750	0.750			4"	O. D.	4.125	4.125	4.125	4.500	4.000	
	Wall	0.049	0.042	0.030				Wall	0.134	0.110	0.095	0.095	0.250	
	I. D.	0.652	0.666	0.690				I. D.	3.857	3.905	3.935	3.935	4.000	
¾"	O. D.	0.875	0.875	0.875	1.050		4½"	O. D.					5.000	
	Wall	0.065	0.045	0.032	0.114			Wall					0.250	
	I. D.	0.745	0.785	0.811	0.822			I. D.					4.500	
1"	O. D.	1.125	1.125	1.125	1.315		5"	O. D.	5.125	5.125	5.125	5.563	5.000	
	Wall	0.065	0.050	0.035	0.127			Wall	0.160	0.125	0.109	0.250	0.063	
	I. D.	0.995	1.025	1.055	1.062			I. D.	4.805	4.875	4.907	5.063	4.874	
1¼"	O. D.	1.375	1.375	1.375	1.660		6"	O. D.	6.125	6.125	6.125	6.625	6.000	
	Wall	0.065	0.055	0.042	0.146			Wall	0.192	0.140	0.122	0.250	0.063	
	I. D.	1.245	1.265	1.291	1.368			I. D.	5.741	5.845	5.881	6.125	5.874	
1½"	O. D.	1.625	1.625	1.625	1.900		7"	O. D.					7.625	7.000
	Wall	0.072	0.060	0.049	0.150			Wall					0.282	0.078
	I. D.	1.481	1.505	1.527	1.600			I. D.					7.062	6.844
2"	O. D.	2.125	2.125	2.125	2.375		8"	O. D.	8.125	8.125	8.125	8.625	8.000	
	Wall	0.083	0.070	0.058	0.157			Wall	0.271	0.200	0.170	0.313	0.094	
	I. D.	1.959	1.985	2.009	2.062			I. D.	7.583	7.725	7.785	8.000	7.812	
2½"	O. D.	2.625	2.625	2.625	2.875	2.500	10"	O. D.	10.125	10.125	10.125	10.000		
	Wall	0.095	0.080	0.065	0.188	0.050		Wall	0.338	0.250	0.212	0.094		
	I. D.	2.435	2.465	2.495	2.500	2.400		I. D.	9.449	9.625	9.701	9.812		
3"	O. D.	3.125	3.125	3.125	3.500	3.000	12"	O. D.	12.125	12.125	12.125			
	Wall	0.109	0.090	0.072	0.219	0.050		Wall	0.405	0.280	0.254			
	I. D.	2.907	2.945	2.981	3.062	2.900		I. D.	11.315	11.565	11.617			

## 9.15 Table 27 - Ductile iron pipe data

Ductile Iron Pipe (Standard Classes)								
Size (in.)	Class							Mortar lining (in.)
	50 (in.)	51 (in.)	52 (in.)	53 (in.)	54 (in.)	55 (in.)	56 (in.)	
3"	O.D.	3.96	3.96	3.96	3.96	3.96	3.96	Std. 0.123 Dbl. 0.250
	Wall	0.25	0.28	0.31	0.34	0.37	0.41	
	I.D.	3.46	3.40	3.34	3.28	3.22	3.14	
4"	O.D.	4.80	4.80	4.80	4.80	4.80	4.80	Std. 0.123 Dbl. 0.250
	Wall	0.26	0.29	0.32	0.35	0.38	0.42	
	I.D.	4.28	4.22	4.16	4.10	4.04	3.93	
6"	O.D.	6.90	6.90	6.90	6.90	6.90	6.90	Std. 0.123 Dbl. 0.250
	Wall	0.25	0.28	0.31	0.34	0.37	0.43	
	I.D.	6.40	6.34	6.28	6.22	6.16	6.04	
8"	O.D.	9.05	9.05	9.05	9.05	9.05	9.05	Std. 0.123 Dbl. 0.250
	Wall	0.27	0.30	0.33	0.36	0.39	0.42	
	I.D.	8.51	8.45	8.39	8.33	8.27	8.21	
10"	O.D.	11.10	11.10	11.10	11.10	11.10	11.10	Std. 0.123 Dbl. 0.250
	Wall	0.39	0.32	0.35	0.38	0.41	0.44	
	I.D.	10.32	10.46	10.40	10.34	10.28	10.16	
12"	O.D.	13.20	13.20	13.20	13.20	13.20	13.20	Std. 0.123 Dbl. 0.250
	Wall	0.31	0.34	0.37	0.40	0.43	0.46	
	I.D.	12.58	12.52	12.46	12.40	12.34	12.22	
14"	O.D.	15.30	15.30	15.30	15.30	15.30	15.30	Std. 0.1875 Dbl. 0.375
	Wall	0.33	0.36	0.39	0.42	0.45	0.51	
	I.D.	14.64	14.58	14.52	14.46	14.40	14.34	
16"	O.D.	17.40	17.40	17.40	17.40	17.40	17.40	Std. 0.1875 Dbl. 0.375
	Wall	0.34	0.37	0.40	0.43	0.46	0.52	
	I.D.	16.72	16.66	16.60	16.54	16.48	16.36	
18"	O.D.	19.50	19.50	19.50	19.50	19.50	19.50	Std. 0.1875 Dbl. 0.375
	Wall	0.35	0.38	0.41	0.44	0.47	0.53	
	I.D.	18.80	18.74	18.68	18.62	18.56	18.44	
20"	O.D.	21.60	21.60	21.60	21.60	21.60	21.60	Std. 0.1875 Dbl. 0.375
	Wall	0.36	0.39	0.42	0.45	0.48	0.54	
	I.D.	20.88	20.82	20.76	20.70	20.64	20.52	
24"	O.D.	25.80	25.80	25.80	25.80	25.80	25.80	Std. 0.1875 Dbl. 0.375
	Wall	0.38	0.41	0.44	0.47	0.50	0.56	
	I.D.	25.04	24.98	24.92	24.86	24.80	24.68	
30"	O.D.	32.00	32.00	32.00	32.00	32.00	32.00	Std. 0.250 Dbl. 0.500
	Wall	0.39	0.43	0.47	0.51	0.55	0.63	
	I.D.	31.22	31.14	31.06	30.98	30.90	30.74	
36"	O.D.	38.30	38.30	38.30	38.30	38.30	38.30	Std. 0.250 Dbl. 0.500
	Wall	0.43	0.48	0.62	0.58	0.45	0.68	
	I.D.	37.44	37.34	37.06	37.14	37.40	36.94	
42"	O.D.	44.50	44.50	44.50	44.50	44.50	44.50	Std. 0.250 Dbl. 0.500
	Wall	0.47	0.53	0.59	0.65	0.71	0.77	
	I.D.	43.56	43.44	43.32	43.20	43.08	42.96	
48"	O.D.	50.80	50.80	50.80	50.80	50.80	50.80	Std. 0.250 Dbl. 0.500
	Wall	0.51	0.58	0.65	0.72	0.79	0.86	
	I.D.	49.78	49.64	49.50	49.36	49.22	49.08	
54"	O.D.	57.10	57.10	57.10	57.10	57.10	57.10	Std. 0.250 Dbl. 0.500
	Wall	0.57	0.65	0.73	0.81	0.89	1.05	
	I.D.	55.96	55.80	55.64	55.48	55.32	55.00	

## 9.16 Table 28 - Cast iron pipe data

Cast iron pipe (Standard classes)									
Size (in.)		A (in.)	B (in.)	C (in.)	D (in.)	Class			
						E (in.)	F (in.)	G (in.)	H (in.)
3"	O.D.	3.80	3.96	3.96	3.96				
	Wall	0.39	0.42	0.45	0.48				
	I.D.	3.02	3.12	3.06	3.00				
4"	O.D.	4.80	5.00	5.00	5.00				
	Wall	0.42	0.45	0.48	0.52				
	I.D.	3.96	4.10	4.04	3.96				
6"	O.D.	6.90	7.10	7.10	7.10	7.22	7.22	7.38	7.38
	Wall	0.44	0.48	0.51	0.55	0.58	0.61	0.65	0.69
	I.D.	6.02	6.14	6.08	6.00	6.06	6.00	6.08	6.00
8"	O.D.	9.05	9.05	9.30	9.30	9.42	9.42	9.60	9.60
	Wall	0.46	0.51	0.56	0.60	0.66	0.66	0.75	0.80
	I.D.	8.13	8.03	8.18	8.10	8.10	8.10	8.10	8.00
10"	O.D.	11.10	11.10	11.40	11.40	11.60	11.60	11.84	11.84
	Wall	0.50	0.57	0.62	0.68	0.74	0.80	0.86	0.92
	I.D.	10.10	9.96	10.16	10.04	10.12	10.00	10.12	10.00
12"	O.D.	13.20	13.20	13.50	13.50	13.78	13.78	14.08	14.08
	Wall	0.54	0.62	0.68	0.75	0.82	0.89	0.97	1.04
	I.D.	12.12	11.96	12.14	12.00	12.14	12.00	12.14	12.00
14"	O.D.	15.30	15.30	15.65	15.65	15.98	15.98	16.32	16.32
	Wall	0.57	0.66	0.74	0.82	0.90	0.99	1.07	1.16
	I.D.	14.16	13.98	14.17	14.01	14.18	14.00	14.18	14.00
16"	O.D.	17.40	17.40	17.80	17.80	18.16	18.16	18.54	18.54
	Wall	0.60	0.70	0.80	0.89	0.98	1.08	1.18	1.27
	I.D.	16.20	16.00	16.20	16.02	16.20	16.00	16.18	16.00
18"	O.D.	19.50	19.50	19.92	19.92	20.34	20.34	20.78	20.78
	Wall	0.64	0.75	0.87	0.96	1.07	1.17	1.28	1.39
	I.D.	18.22	18.00	18.18	18.00	18.20	18.00	18.22	18.00
20"	O.D.	21.60	21.60	22.06	22.06	22.54	22.54	23.02	23.02
	Wall	0.67	0.80	0.92	1.03	1.15	1.27	1.39	1.51
	I.D.	20.26	20.00	20.22	20.00	20.24	20.00	20.24	20.00
24"	O.D.	25.80	25.80	26.32	26.32	26.90	26.90	27.76	27.76
	Wall	0.76	0.98	1.05	1.16	1.31	1.45	1.75	1.88
	I.D.	24.28	24.02	24.22	24.00	24.28	24.00	24.26	24.00
30"	O. D.	31.74	32.00	32.40	32.74	33.10	33.46		
	Wall	0.88	1.03	1.20	1.37	1.55	1.73		
	I.D.	29.98	29.94	30.00	30.00	30.00	30.00		
36"	O.D.	37.96	38.30	38.70	39.16	39.60	40.04		
	Wall	0.99	1.15	1.36	1.58	1.80	2.02		
	I.D.	35.98	36.00	35.98	36.00	36.00	36.00		
42"	O.D.	44.20	44.50	45.10	45.58				
	Wall	1.10	1.28	1.54	1.78				
	I.D.	42.00	41.94	42.02	42.02				
48"	O.D.	50.55	50.80	51.40	51.98				
	Wall	1.26	1.42	1.71	1.99				
	I.D.	47.98	47.96	47.98	48.00				
54"	O.D.	56.66	57.10	57.80	58.40				
	Wall	1.35	1.55	1.90	2.23				
	I.D.	53.96	54.00	54.00	53.94				
60"	O.D.	62.80	63.40	64.20	64.28				
	Wall	1.39	1.67	2.00	2.38				
	I.D.	60.02	60.06	60.20	60.06				
72"	O.D.	75.34	76.00	76.88					
	Wall	1.62	1.95	2.39					
	I.D.	72.10	72.10	72.10					
84"	O.D.	87.54	88.54						
	Wall	1.72	2.22						
	I.D.	84.10	84.10						

Spirax Sarco, Inc.  
1150 Northpoint Blvd., Blythewood, SC 29016  
1-800-883-4411  
[www.spiraxsarco.com/global/us](http://www.spiraxsarco.com/global/us)